

EL5000 Hot Sheet

System PN 59000 (Mach 2) Balboa Instruments

System Model # EL5-EL5000-YCAH

Base PCBA PN
EL5000 – 59001

Base Panels
ML 700 – PN 52649
ML 900 – PN 52654

The ML 700 Panel may require Aux
panels for adequate functionality.



Circuit Board Configuration

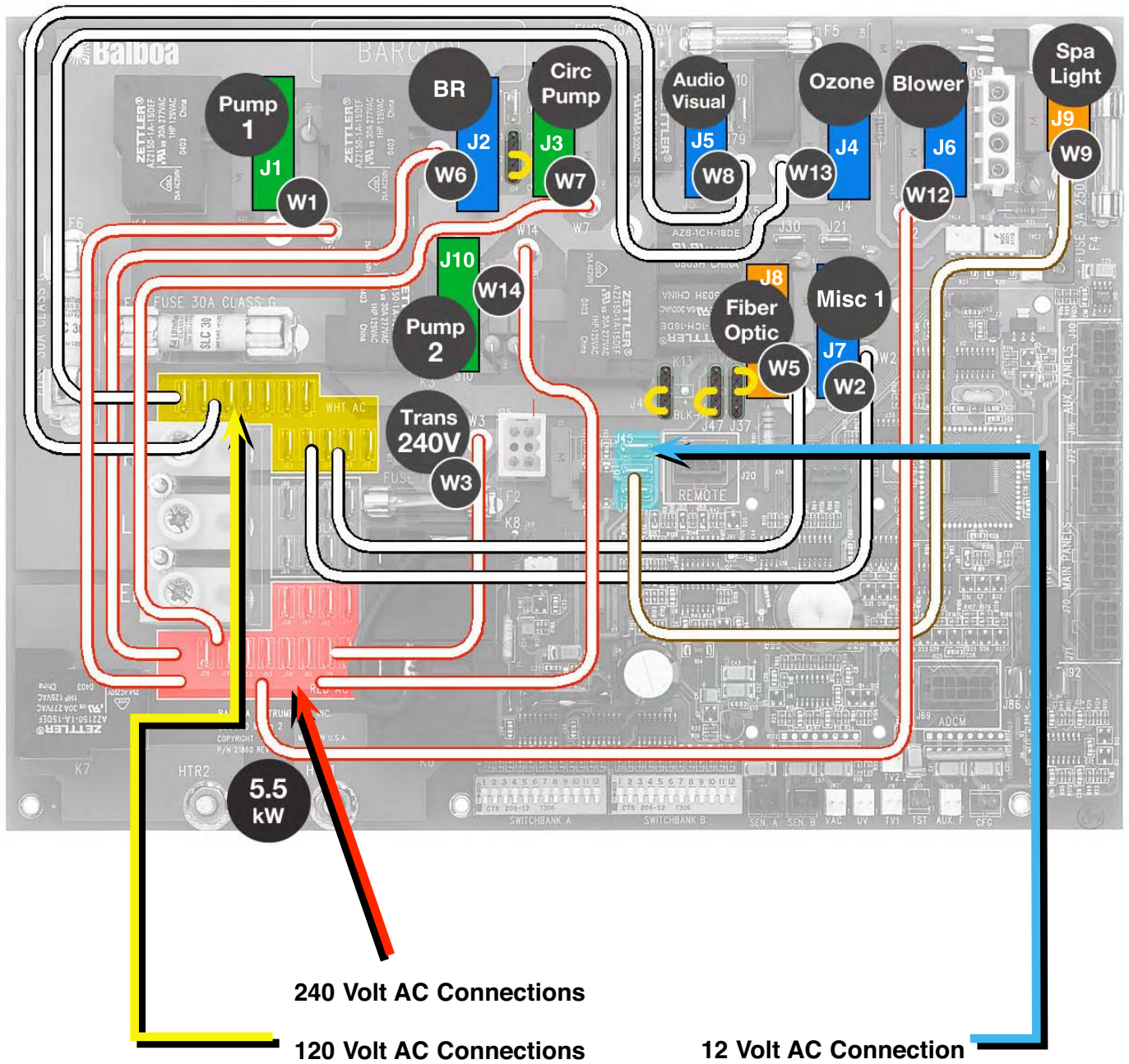

Circuit Board Layout

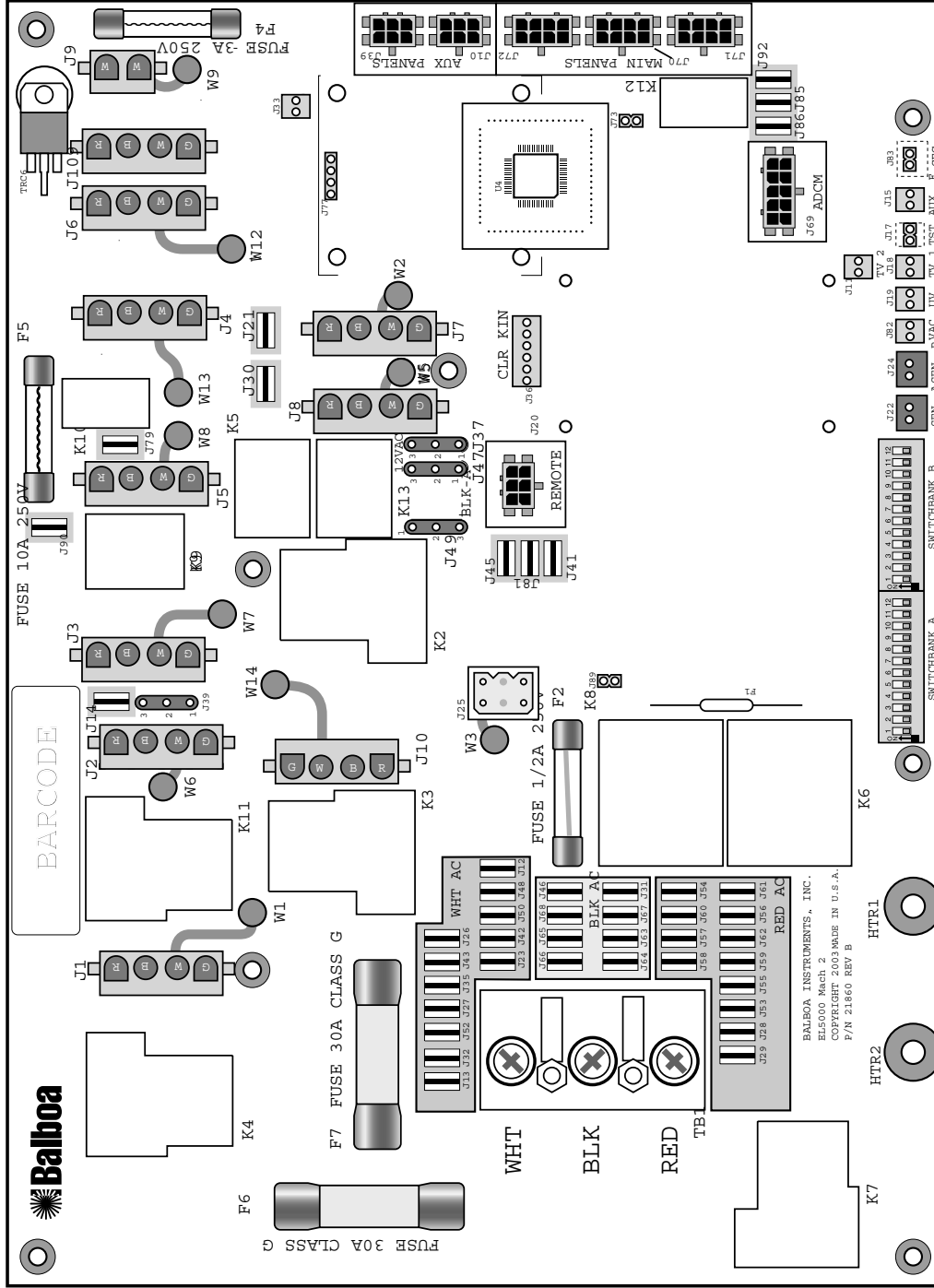

J1 & W1 . . . Pump 1

J2 & W6 . . . BR
With J39

J3 & W7 . . . Circ Pump

J4 & W13 Ozone

J5 & W8 . . . A.V.

J6 & W12 Blower

J7 & W2 . . . Misc. 1

J8 & W5 . . . Fiber Optic
With J47 and J49

J9 & W9 . . . Light
With J37

J10 & W14 Pump 2

J109 & W9 Light (opt.)

DIP Switches and Jumpers

Switchbank A

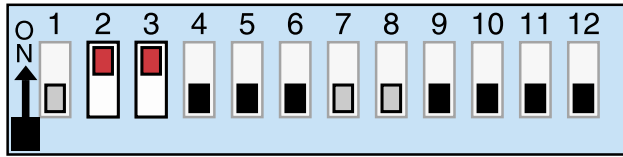

- | | |
|---------------------------------|------------------------------------|
| A1, Test Mode OFF | A7, Cleanup Cycle OFF |
| A2/A3, Four H.S. Pumps w/Heater | A8, 1Hr O ₃ Disable OFF |
| A4, 12 Hour Time | A9/A10, No Circ Pump |
| A5, Degrees F | A11, Ozone w/P1 low |
| A6, Short Timeouts | A12, Memory ON |

Switchbank B

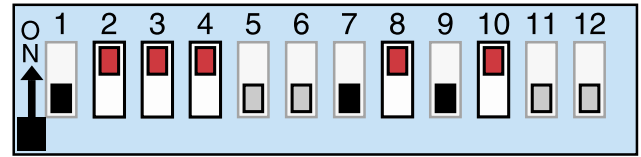

- | | |
|-------------------------------|----------------------|
| B1, Pump 2 2-Speed | B7, Dimmable Light |
| B2/B3, 3-Speed Blower (H/M/L) | B8, Spa Light Button |
| B4, F/O Light ON | B9, N/A |
| B5, Pump 3 OFF | B10, Pump 2 Enabled |
| B6, Scrunching OFF | B11, Mister Disabled |
| | B12, N/A |

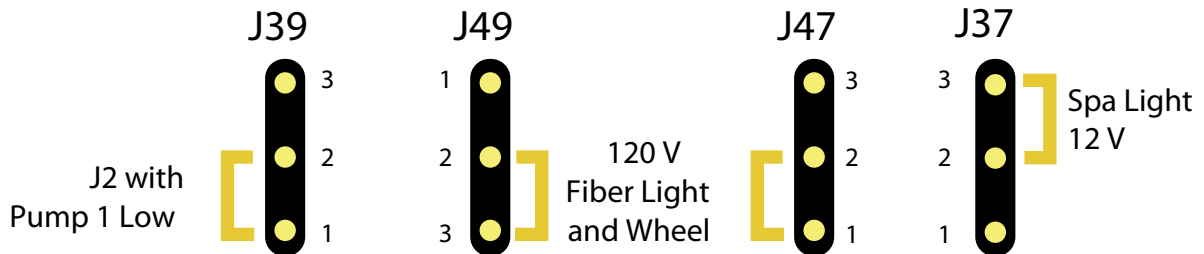



Jumper Key

- J37 Jumper on Pin 1 and 2 will power one leg of J9 (Spa Light) at 120 Volts AC.
 Jumper on Pin 2 and 3 will power one leg of J9 (Spa Light) at 12 Volts AC.
 Note: W9 controls voltage on the other leg of J9 and must be set for the same voltage.
- J39 Jumper on Pin 1 and 2 will power J2 with Pump 1 Low.
 Jumper on Pin 2 and 3 will power J2 with the Circ Pump.
- J47 Jumper on Pin 1 and 2 will power J8 (Fiber Optic) at 120 Volts AC.
 Jumper on Pin 2 and 3 will power J8 (Fiber Optic) at 12 Volts AC.
- J49 Jumper on Pin 2 and 3 will power J8 (Fiber Optic) at 120 Volts AC.
 Jumper on Pin 1 and 2 will power J8 (Fiber Optic) at 12 Volts AC.
 Note: J47 and J49 must be set for the same voltage.

DIP Switch Definitions

DIP Switch Key

- A 1 Test Mode (normally Off)
- A2 and A 3 See **Figure 1** to control amp draw requirements
- A 4 Displays time in 24 hours (military time) – in ON position.
Displays 12 hour time when OFF
- A 5 Celsius (ON) or Fahrenheit (OFF) Temperature Display
- A 6 Timeout settings:15 minutes except 2 hr for P1 low (Off)
or
30 minutes except 4 hr for P1 low (On)
- A 7 Cleanup Cycle – 30 min after spa use/timeout,
P1-low & Ozone run for 1 hour.
- A 8 Ozone Suppression for one hour after pump/blower button press
- A9 and A 10 See **Figure 2** for Circ Pump Behavior settings
- A 11 Ozone in Filter Cycle only when ON (non-circ mode – A9 and A10 OFF)
Ozone whenever Pump 1 Low is running when OFF
One-Speed Pump 1 when ON (in any circ mode) 
Two-Speed Pump 1 when OFF (in any circ mode) 
(Refer to **Figure 2**)
- A 12 Battery Backup Reset

- B 1 Single-speed Pump 2 when ON, Two-speed Pump 2 when OFF
- B2 and B 3 See **Figure 3**
- B 4 Fiber Optic and Color Wheel control
(converts Spa Light to Fiber Optic control on panels with a single light button)
- B 5 Pump 3 enable when On. Jets 3 replaces Blower on Aux panel.
- B 6 Panel Scrunching enabled on ML900 when ON
- B 7 Spa Light On/Off (ON Position) or Dimmable (OFF Position)
- B 8 Spa Light Enable on separate light button when ON
- B 9 N/A
- B 10 Pump 2 Enable when ON
- B 11 Mister Enable when ON
- B 12 N/A

		Circ Pump Behavior	
A9	A10		
OFF	OFF	No Circ Pump	
ON	OFF	24 Hr	
OFF	ON	24 Hr w/3° Shut-Off	
ON	ON	Acts like P1 low (Filter Cycles, Polls)	

Figure 2

		# of Hi-Speed Pumps/Blower with Heater
A2	A3	
OFF	OFF	0
ON	OFF	1
OFF	ON	2
ON	ON	Up to 4

Figure 1

B2	B3	Blower Speeds
OFF	OFF	0 (No Blower)
ON	OFF	1 (on/off)
OFF	ON	2
ON	ON	3

Figure 3

Ozone Connections

First, configure the EL Circuit Board to deliver the desired voltage to the on-board connector (J4). Connect the W-13 wire to either White AC (120V) or Red AC (240V) to set the voltage.

The pin next to ground determines voltage on these connectors. Ground is typically the bottom pin of the white connector (if the flat sides of the top and bottom holes are to the left and the heater connections are on the bottom edge of the board).

The pin next to the bottom (ground) pin of J9 is fed by W-13 and sets the voltage in the connector.

If the board is set up to operate a 120V ozone generator, the connector on the ozone generator is likely to be configured correctly, but should be compared to the illustration below.

If a 240V ozone generator is required, be sure the red wire in the ozone cord is positioned in the connector next to the green ground wire as described below.

Note: A special tool is required to remove the pins from the connector body once they are snapped in place. Check with your Balboa Account Manager for information on purchasing a pin-removal tool.

Ozone connector configuration for 120V

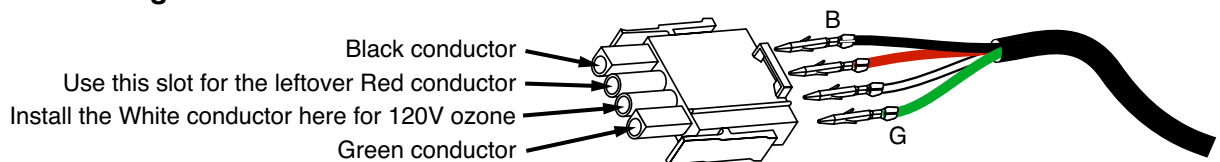

Ozone connector configuration for 240V

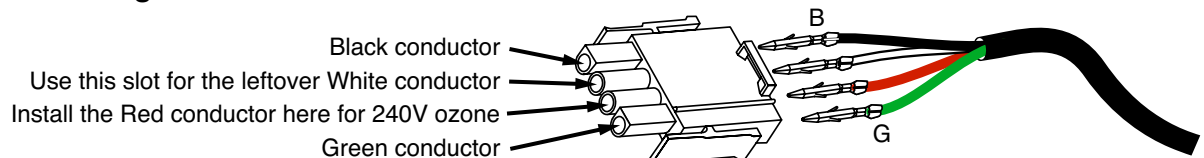

Panel Configuration

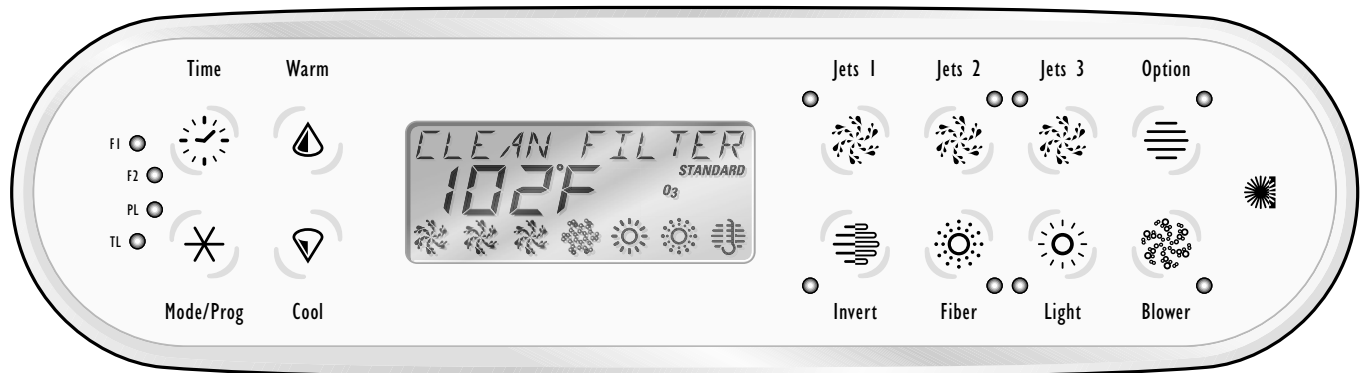

ML 900
PN 52654

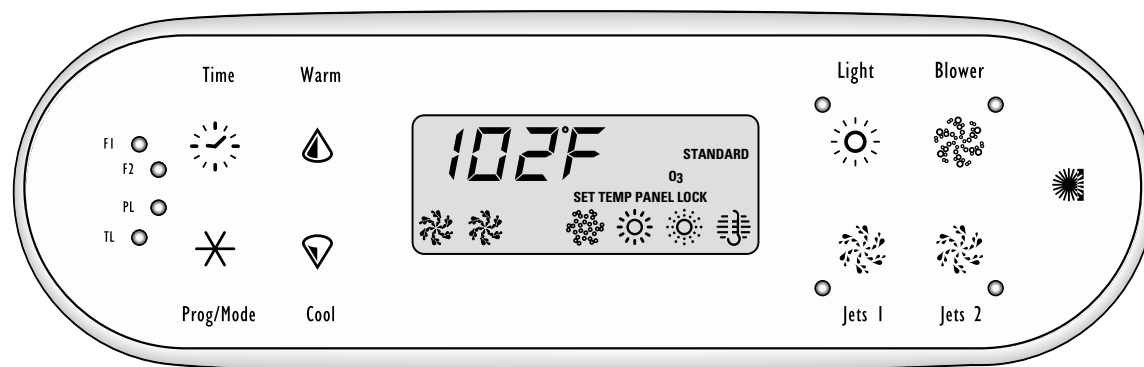

ML 700
PN 53649

Auxiliary panels are available in the following configurations:

Infrared Remote (Dolphin) which has a separate connector on the board.

4-Button
2-Button
1-Button

Configuration of the 4-Button and 2-Button Aux Panels can be done for custom applications.

1-button Aux panels are available in 4 different versions.

There are four Aux Panel connectors on the board.

Panel “Scrunching” on the ML 900 (requires custom panel overlays)

With DIP switch B6, unused buttons on an ML 900 can be “scrunched” in a custom configuration or the unused positions can be left blank.

Scrunching moves the buttons in a counter-clockwise direction from the bottom row to the top row, on the right side of the display. The result is that all missing buttons or gaps appear on the bottom row, just to the right of the display.

Note: Some button positions MUST be used in order to perform certain functions. For instance, the Jets 2 button and the Blower button are used in certain button press combinations, and need to be available to a user, even if they are labeled with a different name.

See reference cards for details.