

BP7 Tech Sheet - for Aftermarket use only

Customer: Balboa Water Group - Aftermarket Division

Part Number: G4361-02 800 Incoloy 4.0kW
G5361-02 800 Incoloy 5.5kW



Genuine Balboa Box Overlay

UL System Model (5.5kw): BP20-BP7-AU

UL System Model (4.0kw): BP20-BP7-AS

Software Version ID: M100_221 V65.0

Software Version: 65.0

File Name: BP1800_65.0_BP7.hex

Configuration Signature: FF69032A

Eng. Project Number: 5663

Control Panels:

spaTouch™3	Any version (version 3.2 or later required for Clim8zone™ heat pump support)
spaTouch™2	Any version (version 2.19 or later required for CHROMAZON3™ support; version 2.36 or later required for Clim8zone™ heat pump support)
Icon spaTouch™	Any version (version 3.36 or later required for bba™2 fully integrated functionality)
Menued spaTouch™	Any version (version 2.8 or later required for bba™2 integrated functionality)
TP900	Version 3.1 and later (Version 3.13 or later required for bba™)
TP800	Version 3.1 and later (Version 3.13 or later required for bba™; version 4.11 or later required for bba™2 integrated functionality)
TP700/TP740	Any version (version 1.27 or later required for Clim8zone™ heat pump support)
TP600	Version 2.7 and later (Version 2.12 or later required for bba™/bba™2 On/Off control via menu)
TP500	Any version -- Note: The TP500 works in the same Setups in which the TP400T works; see the TP400 page for details
TP400T US	Version 2.7 and later (TP400T CE may be used) (Version 2.12 or later required for bba™/bba™2 On/Off control via menu)
TP400W US	Version 2.7 and later (TP400W CE may be used) (Version 2.12 or later required for bba™/bba™2 On/Off control via menu)
TP200T	Any version
TP200W	Any version

Manufactured under one or more of these patents. U.S. Patents: 5332944, 5361215, 5550753, 5559720, 5,883,459, 6253227, 6282370, 6590188, 6976052, 6965815, 7030343, 7,417,834 b2, Canadian Patent: 2342614, Australian patent: 2373248 other patents both foreign and domestic applied for and pending. © Copyright 2009 Balboa Water Group.

System Revision History

Part #	EPN	Date	Originator	Changes Made
G4361 G5361	5342	03-11-20	BWG	Stripped-down version of BP2000 board, with no remote support, no real-time clock, & no low speed relay for Pump 2, named the BP1800 board. Generic BP7 system for aftermarket use, based on this board, with 32 Setups.
G4361-01 G5361-01	5563	06-23-21	BWG	Update with Wago terminal block (later discontinued).
G4361-02 G5361-02	5663	06-20-23	BWG	Update to support Clim8zone™ heat pump. Make AV only work at 240V.

bba™ 2 / bba™ 3 (Balboa Bluetooth Amp) connection is documented separately.

bba™ 2 / bba™ 3 is integrated into graphic display panels (TP700, TP800, TP900 and spaTouch™).

With TP600/TP500/TP400, use the “BT” entry on the menu to toggle bba™ 2 / bba™ 3 power On/Off.

Basic Functions Setup 1-32

Power Requirements:

240VAC, 50/60Hz*, 48A, Class A GFCI-protected service (Circuit Breaker = 60A max.),
4 wires [hot, hot, neutral, ground]

240VAC “dedicated”, 50/60Hz*, 48A, Class A GFCI-protected service (Circuit Breaker = 60A max.),
3 wires [hot, hot, ground]

* BP systems automatically detect 50Hz vs 60Hz. However, power frequency (50Hz vs 60Hz) is just one of many differences between North American (UL) and CE power, and it is because of these other differences that different BP systems must be used for UL vs CE territories. Also, there are a few countries that use CE power but 60 Hz (such as South Korea) which need CE systems, and a few countries that use UL power but 50 Hz which need UL systems.

HiPot Testing Note:

Disconnect slip terminal with green wires from J6 prior to performing HiPot test. Failure to disconnect may cause a false failure of the test. Reconnect terminal to J6 after successful completion of HiPot test.

Basic Functions Setup 1-32

System Outputs:

Pump 1	240VAC	2-Speed 1-Speed in Setups 3, 5, 11, 14, 16, 24, 26 & 31	12A max	15-minute timer for High Speed, 15-Minute timer for Low Speed
		This is the heater pump in Setups 6-8, 17-21, 27-29 & 32 Must deliver 20 GPM through heater		
Pump 2	240VAC	2-Speed 1-Speed in Setups 2, 3, 7, 10, 11, 13, 14, 18, 20, 23, 24, 28 & 30-32 Unused in Setups 4, 5, 8, 15, 16, 21, 25, 26 & 29	10A†/12A max	15-minute timer
Pump 3	240VAC	1-Speed Unused in Setups 1-8, 12-16 & 19-29	12A max	15-minute timer
Pump 4	240VAC	1-Speed Unused in Setups 1-29	10A† max	15-minute timer
Blower	240VAC	1 Speed Unused in Setups 9-32	4A max	15-minute timer
MicroSilk®	240VAC	1-Speed Used in Setups 22-29 only	8A max*	30-minute timer
Circ Pump	240VAC**	1-Speed This is the heater pump in Setups 1-5, 9-16, 22-26, 30 & 31 Must deliver 20 GPM through heater	2A max	Programmable Filtration Cycles + Polling
Ozone	240VAC**		.5A max	Slaved to Circ Pump in Setups 1-5, 9-16, 22-26, 30 & 31 Independent in Setups 6-8, 17-21, 27-29 & 32
Spa Light	10VAC	On/Off	2A* max	240-minute timer.
AV + C8Z***	240VAC	Hot	2A + 8A max	Always on
Heater	5.5kW @ 240VAC 4.0kW @ 240VAC			

MicroSilk® is a registered trademark of Jason International

** Both the Circ pump and Ozone can be converted to 120V, however they will be the same voltage after conversion. (Both 120V or both 240V.)

*** Optional splitter PN 22934 can be used to connect two things, such as an audio device and Clim8zone™(C8Z), to J33.

† In Setups 30-32, where pump 2 and pump 4 are both on the expander board, pump 2 and pump 4 must add up to no more than 20A total.

The above limits are for a 48A service (60A breaker). If using a smaller service, smaller maximums may be required, depending on the Setup.

* 2A max limit is shared by On/Off Spa Light and CHROMAZON3™.

Manufactured under one or more of these patents. U.S. Patents: 5332944, 5361215, 5550753, 5559720, 5,883,459, 6253227, 6282370, 6590188, 6976052, 6965815, 7030343, 7,417,834 b2, Canadian Patent: 2342614, Australian patent: 2373248 other patents both foreign and domestic applied for and pending. © Copyright 2009 Balboa Water Group.



Hardware Setup

Wiring Diagram

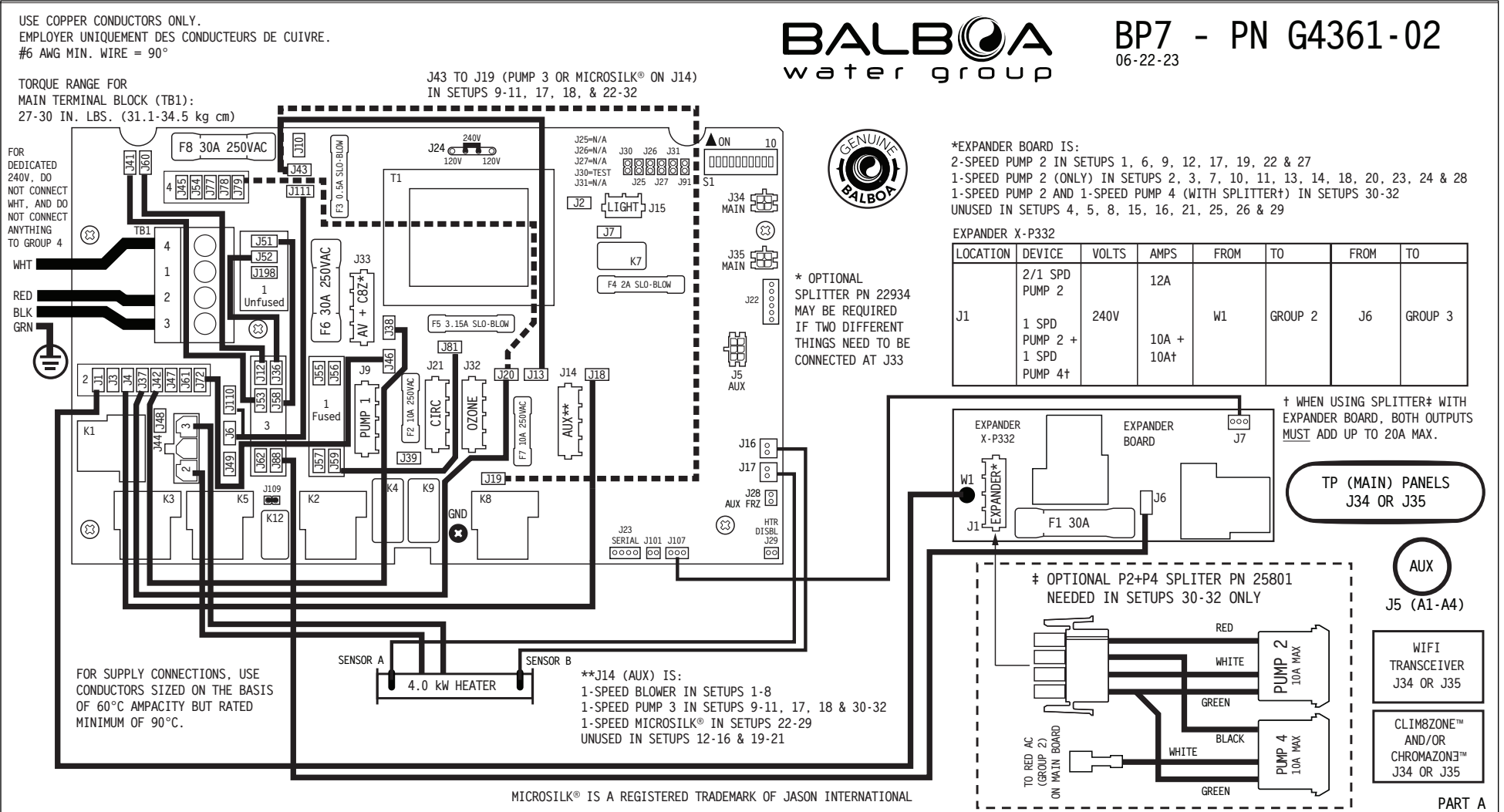

Hardware Setup

Settings

SETUP #	CIRC PUMP	PUMP 1	PUMP 2	PUMP 3	PUMP 4	BLOWER	MICROSILK®	TEMP SCALE
1	PROGRAMMABLE FILTRATION + POLLING	2-SPEED	2-SPEED	NONE	NONE	1-SPEED	NONE	°F
2	PROGRAMMABLE FILTRATION + POLLING	2-SPEED	1-SPEED	NONE	NONE	1-SPEED	NONE	°F
3	PROGRAMMABLE FILTRATION + POLLING	1-SPEED	1-SPEED	NONE	NONE	1-SPEED	NONE	°F
4	PROGRAMMABLE FILTRATION + POLLING	2-SPEED	NONE	NONE	NONE	1-SPEED	NONE	°F
5	PROGRAMMABLE FILTRATION + POLLING	1-SPEED	NONE	NONE	NONE	1-SPEED	NONE	°F
6	NONE	2-SPEED	2-SPEED	NONE	NONE	1-SPEED	NONE	°F
7	NONE	2-SPEED	1-SPEED	NONE	NONE	1-SPEED	NONE	°F
8	NONE	2-SPEED	NONE	NONE	NONE	1-SPEED	NONE	°F
9	PROGRAMMABLE FILTRATION + POLLING	2-SPEED	2-SPEED	1-SPEED	NONE	NONE	NONE	°F
10	PROGRAMMABLE FILTRATION + POLLING	2-SPEED	1-SPEED	1-SPEED	NONE	NONE	NONE	°F
11	PROGRAMMABLE FILTRATION + POLLING	1-SPEED	1-SPEED	1-SPEED	NONE	NONE	NONE	°F
12	PROGRAMMABLE FILTRATION + POLLING	2-SPEED	2-SPEED	NONE	NONE	NONE	NONE	°F
13	PROGRAMMABLE FILTRATION + POLLING	2-SPEED	1-SPEED	NONE	NONE	NONE	NONE	°F
14	PROGRAMMABLE FILTRATION + POLLING	1-SPEED	1-SPEED	NONE	NONE	NONE	NONE	°F
15	PROGRAMMABLE FILTRATION + POLLING	2-SPEED	NONE	NONE	NONE	NONE	NONE	°F
16	PROGRAMMABLE FILTRATION + POLLING	1-SPEED	NONE	NONE	NONE	NONE	NONE	°F
17	NONE	2-SPEED	2-SPEED	1-SPEED	NONE	NONE	NONE	°F
18	NONE	2-SPEED	1-SPEED	1-SPEED	NONE	NONE	NONE	°F
19	NONE	2-SPEED	2-SPEED	NONE	NONE	NONE	NONE	°F
20	NONE	2-SPEED	1-SPEED	NONE	NONE	NONE	NONE	°F
21	NONE	2-SPEED	NONE	NONE	NONE	NONE	NONE	°F
22	PROGRAMMABLE FILTRATION + POLLING	2-SPEED	2-SPEED	NONE	NONE	NONE	1-SPEED	°F
23	PROGRAMMABLE FILTRATION + POLLING	2-SPEED	1-SPEED	NONE	NONE	NONE	1-SPEED	°F
24	PROGRAMMABLE FILTRATION + POLLING	1-SPEED	1-SPEED	NONE	NONE	NONE	1-SPEED	°F
25	PROGRAMMABLE FILTRATION + POLLING	2-SPEED	NONE	NONE	NONE	NONE	1-SPEED	°F
26	PROGRAMMABLE FILTRATION + POLLING	1-SPEED	NONE	NONE	NONE	NONE	1-SPEED	°F
27	NONE	2-SPEED	2-SPEED	NONE	NONE	NONE	1-SPEED	°F
28	NONE	2-SPEED	1-SPEED	NONE	NONE	NONE	1-SPEED	°F
29	NONE	2-SPEED	NONE	NONE	NONE	NONE	1-SPEED	°F
30‡	PROGRAMMABLE FILTRATION + POLLING	2-SPEED	1-SPEED	1-SPEED	1-SPEED	NONE	NONE	°F
31‡	PROGRAMMABLE FILTRATION + POLLING	1-SPEED	1-SPEED	1-SPEED	1-SPEED	NONE	NONE	°F
32‡	NONE	2-SPEED	1-SPEED	1-SPEED	1-SPEED	NONE	NONE	°F

‡SETUPS 30-32 REQUIRE SPLITTER PN 25801



BP7 - PN G4361-02

06-22-23

CONNECT ONLY TO CIRCUITS PROTECTED BY A CLASS A GFCI.

A DISCONNECTING MEANS MUST BE INSTALLED WITHIN SIGHT FROM THE EQUIPMENT AND AT LEAST 5 FEET (1.52 M) FROM THE INSIDE WALLS OF THE POOL, SPA, OR HOT TUB.

TOTAL OUTPUT AMP DRAW NOT TO EXCEED MAX INPUT RATING OF SPA
USE EARTH GROUND CONNECTIONS AS INDICATED INSIDE THE SYSTEM ENCLOSURE

----- INSTEAD OF
SETUP #21,
THIS SYSTEM IS
CONFIGURED IN
SETUP #:



SWITCHBANK S1 OFF

TEST MODE OFF	◀ A1
DON'T ADD 1 HS PUMP W/HTR	◀ A2**
DON'T ADD 2 HS PUMPS W/HTR	◀ A3
DON'T ADD 4 HS PUMPS W/HTR	◀ A4
SPECIAL AMPERAGE RULE A	◀ A5
STORE SETTINGS*	◀ A6
1 MIN HTR COOLDOWN (ELEC)	◀ A7
NOT ASSIGNED	◀ A8
NOT ASSIGNED	◀ A9
NOT ASSIGNED	◀ A10

SWITCHBANK S1 ON

TEST MODE ON	▶ A1
ADD 1 HS PUMP WITH HEAT**	▶ A2**
ADD 2 HS PUMPS WITH HEAT	▶ A3
ADD 4 HS PUMPS WITH HEAT	▶ A4
SPECIAL AMPERAGE RULE B	▶ A5
MEMORY RESET*	▶ A6
5 MIN HTR COOLDOWN (GAS)	▶ A7
NOT ASSIGNED	▶ A8
NOT ASSIGNED	▶ A9
NOT ASSIGNED	▶ A10

* SWITCH # 6 SHOULD BE SET TO OFF UPON FINAL INSTALLATION.

** SWITCH A2 CAN BE TURNED ON ONLY IF CLIMBZONE™ (C8Z) IS NOT BEING USED.

LOCATION	DEVICE	VOLTS	MAX AMPS	FROM	TO
J9	2/1-SP PUMP 1	240V	12A MAX	J46	GROUP 2
J14	1-SP BLOWER / 1-SP PUMP 3 / 1-SP MICROSILK®	240V	4A MAX / 12A MAX / 8A MAX	J18	GROUP 2
	J14 LINE 1 CONNECTION FOR BLOWER			J43	J13
	J14 LINE 1 CONNECTION FOR P3/MS			J43	J19
J15	SPA LIGHT	10V	2A*		
J21	CIRC PUMP	240V**	2A MAX	J20	GROUP 2
J32	OZONE		0.5A		
	CIRC AND OZONE LINE 1 CONNECTION			J81	J59
J33	AV + CLIMBZONE™ (C8Z)	240V	2A + 8A	J38	GROUP 2
J44	HEATER	240V	4.0 kW		

* 2A LIMIT IS SHARED BY J15 SPA LIGHT AND CHROMAZONE™

** CIRC PUMP + OZONE CAN BE 120V IF J20 IS CONNECTED TO GROUP 4

PART B



Setup Reference Table for Setups 1-16 (Setups 17-32 on next page)

Setup #	Circ Pump	Pump 1	Pump 2	Pump 3	Pump 4	Blower	MicroSilk®	Temp Scale
1	Programmable Filtration + Polling	2-Speed	2-Speed	None	None	1-Speed	None	°F
2	Programmable Filtration + Polling	2-Speed	1-Speed	None	None	1-Speed	None	°F
3	Programmable Filtration + Polling	1-Speed	1-Speed	None	None	1-Speed	None	°F
4	Programmable Filtration + Polling	2-Speed	None	None	None	1-Speed	None	°F
5	Programmable Filtration + Polling	1-Speed	None	None	None	1-Speed	None	°F
6	None	2-Speed	2-Speed	None	None	1-Speed	None	°F
7	None	2-Speed	1-Speed	None	None	1-Speed	None	°F
8	None	2-Speed	None	None	None	1-Speed	None	°F
9	Programmable Filtration + Polling	2-Speed	2-Speed	1-Speed	None	None	None	°F
10	Programmable Filtration + Polling	2-Speed	1-Speed	1-Speed	None	None	None	°F
11	Programmable Filtration + Polling	1-Speed	1-Speed	1-Speed	None	None	None	°F
12	Programmable Filtration + Polling	2-Speed	2-Speed	None	None	None	None	°F
13	Programmable Filtration + Polling	2-Speed	1-Speed	None	None	None	None	°F
14	Programmable Filtration + Polling	1-Speed	1-Speed	None	None	None	None	°F
15	Programmable Filtration + Polling	2-Speed	None	None	None	None	None	°F
16	Programmable Filtration + Polling	1-Speed	None	None	None	None	None	°F

Color Key	Output
	XP332
	XP332 and Splitter
	J14 (Aux) on Main Board

Setup Reference Table for Setups 17-32 (Setups 1-16 on previous page)

Setup #	Circ Pump	Pump 1	Pump 2	Pump 3	Pump 4	Blower	MicroSilk®	Temp Scale
17	None	2-Speed	2-Speed	1-Speed	None	None	None	°F
18	None	2-Speed	1-Speed	1-Speed	None	None	None	°F
19	None	2-Speed	2-Speed	None	None	None	None	°F
20	None	2-Speed	1-Speed	None	None	None	None	°F
21	None	2-Speed	None	None	None	None	None	°F
22	Programmable Filtration + Polling	2-Speed	2-Speed	None	None	None	1-Speed	°F
23	Programmable Filtration + Polling	2-Speed	1-Speed	None	None	None	1-Speed	°F
24	Programmable Filtration + Polling	1-Speed	1-Speed	None	None	None	1-Speed	°F
25	Programmable Filtration + Polling	2-Speed	None	None	None	None	1-Speed	°F
26	Programmable Filtration + Polling	1-Speed	None	None	None	None	1-Speed	°F
27	None	2-Speed	2-Speed	None	None	None	1-Speed	°F
28	None	2-Speed	1-Speed	None	None	None	1-Speed	°F
29	None	2-Speed	None	None	None	None	1-Speed	°F
30	Programmable Filtration + Polling	2-Speed	1-Speed	1-Speed	1-Speed	None	None	°F
31	Programmable Filtration + Polling	1-Speed	1-Speed	1-Speed	1-Speed	None	None	°F
32	None	2-Speed	1-Speed	1-Speed	1-Speed	None	None	°F

System (and any replacement board)
is shipped in Setup 21

Color Key	Output
	XP332
	XP332 and Splitter
	J14 (Aux) on Main Board

Changing Software Setups with spaTouch™ Icon-Driven Panels

Test Menu Access (S1, Switch 1 ON) *Service Technician ONLY.*

DANGER! HIGH VOLTAGE WILL BE ACCESSIBLE! SERVICE TECHNICIAN ONLY!

While the system is running, move DIP Switch 1 (on S1 on the Main circuit board) to ON. The system will enter Test Mode. Moving DIP Switch 1 to OFF will exit Test Mode.

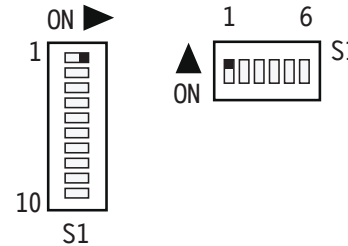

The example screens shown here are from the spaTouch 1 Icon-Driven Panel, but the screens on the spaTouch 2 Panel are similar. The main difference is that the spaTouch 2 display is wider.

To Change Software Setups:

While in Test Mode, press the indicated icons to move from screen to screen.

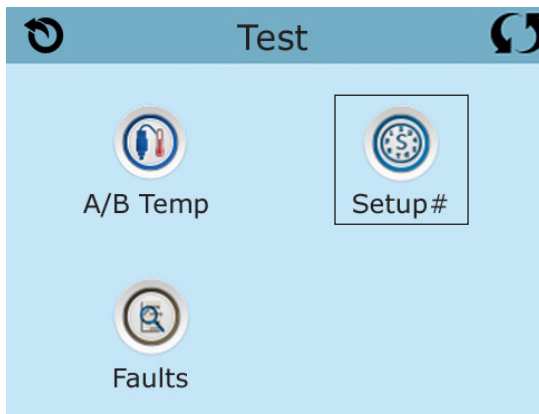
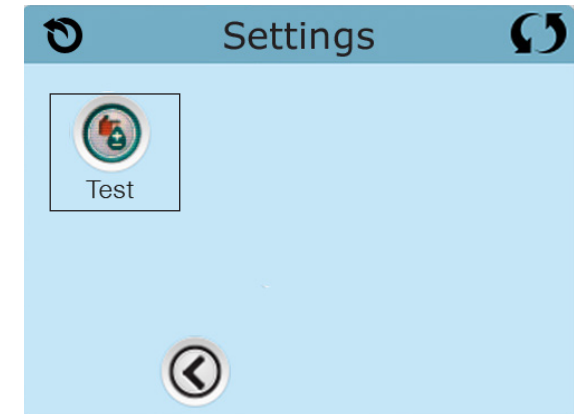
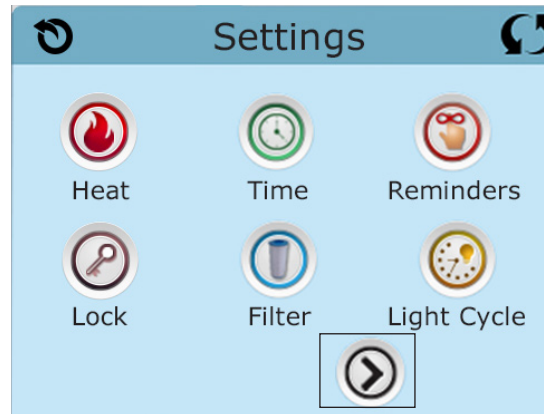
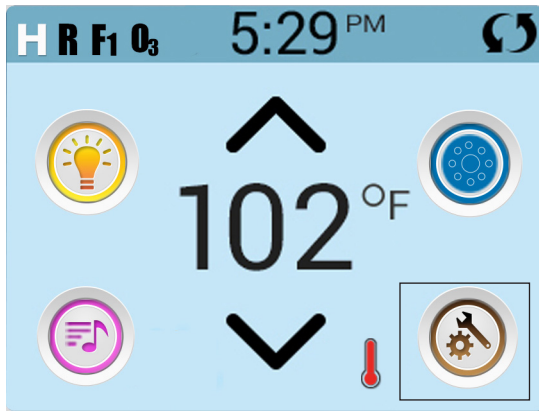

Once on the Setup Selection screen, press the Up or Down icon to select the desired Setup Number, then press the Check Mark icon to confirm and to have the spa restart.

After the system restarts, you may see a message that "The settings have been reset"; this is normal after changing Setups with DIP Switch 6 in the OFF position. Press "Clear" to dismiss this message.

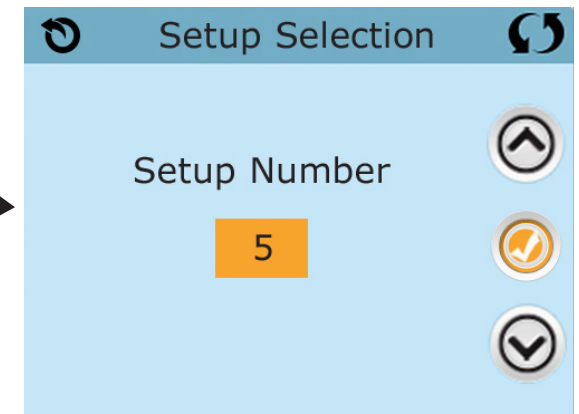

Manufactured under one or more of these patents. U.S. Patents: 5332944, 5361215, 5550753, 5559720, 5,883,459, 6253227, 6282370, 6590188, 6976052, 6965815, 7030343, 7,417,834 b2, Canadian Patent: 2342614, Australian patent: 2373248 other patents both foreign and domestic applied for and pending. © Copyright 2009 Balboa Water Group.

Changing Software Setups with TP800 / TP900 / spaTouch™ Menued Panel

Test Menu Access (S1, Switch 1 ON) *Service Technician ONLY.*

DANGER! HIGH VOLTAGE WILL BE ACCESSIBLE! SERVICE TECHNICIAN ONLY!

While the system is running, move DIP Switch 1 (on S1 on the Main circuit board) to ON.
The system will enter Test Mode.
Moving DIP Switch 1 to OFF will exit Test Mode.

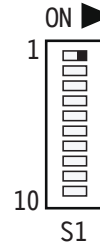

Software Setups

Under the TEST Menu, the Setup screen will allow changing the Setup from 1 to any number established by the Manufacturer.
Changing the Setup may require wiring changes as well.

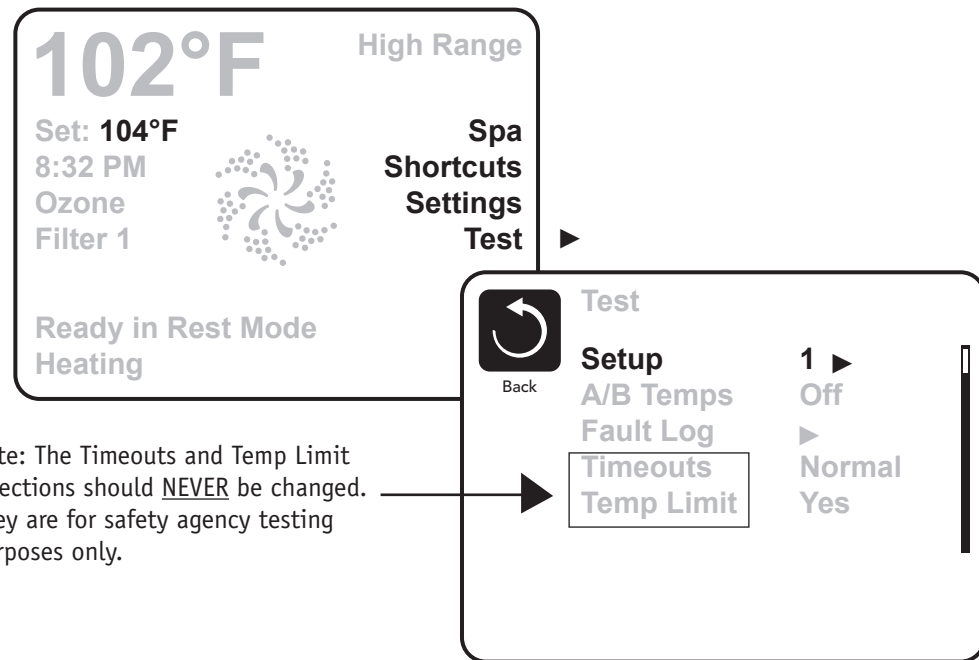

Note: The Timeouts and Temp Limit selections should NEVER be changed. They are for safety agency testing purposes only.

Changing Software Setups with TP600/TP500/TP400/TP200

Test Menu Access (S1, Switch 1 ON) *Service Technician ONLY.*

DANGER! HIGH VOLTAGE WILL BE ACCESSIBLE! SERVICE TECHNICIAN ONLY!

While the system is running, move DIP Switch 1 (on S1 on the Main circuit board) to ON. The system will enter Test Mode. Moving DIP Switch 1 to OFF will exit Test Mode.

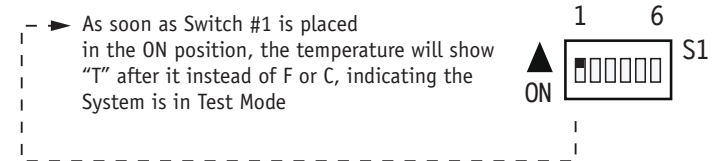

Software Setups

Under the TEST Menu, the Setup screen will allow changing the Setup from 1 to any number established by the Manufacturer. Changing the Setup may require wiring changes as well.

You will have 1 minute to complete the setup change after you manually exit Priming Mode. (Once familiar with the process, the Setup change should take less than 15 seconds.)



When the panel displays RUN PMPS PURG AIR, press any Temperature button ONCE to exit Priming Mode. You should see "---T" where the T indicates the system is in Test Mode.

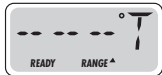

Continued on Next Page.

Changing Software Setups with TP600/TP500/TP400/TP200 Continued

Again, **You will have 1 minute** to complete the setup change after you manually exit Priming Mode.

NOTE: Whenever the below says Warm or Temp followed by Light, **on the TP500** press Menu instead of Warm or Temp followed by light. And whenever the chart below says Light, **on the TP500** press Menu instead of Light.

Immediately after exiting Priming Mode, press this sequence of buttons: Warm*, Light, Warm, Warm, Warm, Warm. Continue to press Warm until the display shows the Setup Number (S-01, S-02, etc.) you want to switch to. When the correct setup number is showing, press Light once, and the system will reset, using the newly-selected Setup from that point on.

Move DIP Switch 1 to the OFF position to take the spa out of Test Mode. °F or °C will replace °T.

Using a permanent marker, write the Setup number on the Setup label mounted inside the system lid (right). This is very important to any service person in the future who may need to replace a circuit board or system and needs to change the Setup on a replacement part while in the field.

NOTE: Changing the Setup may require wiring changes as well - refer to the wiring diagram or wiring diagram addendum.

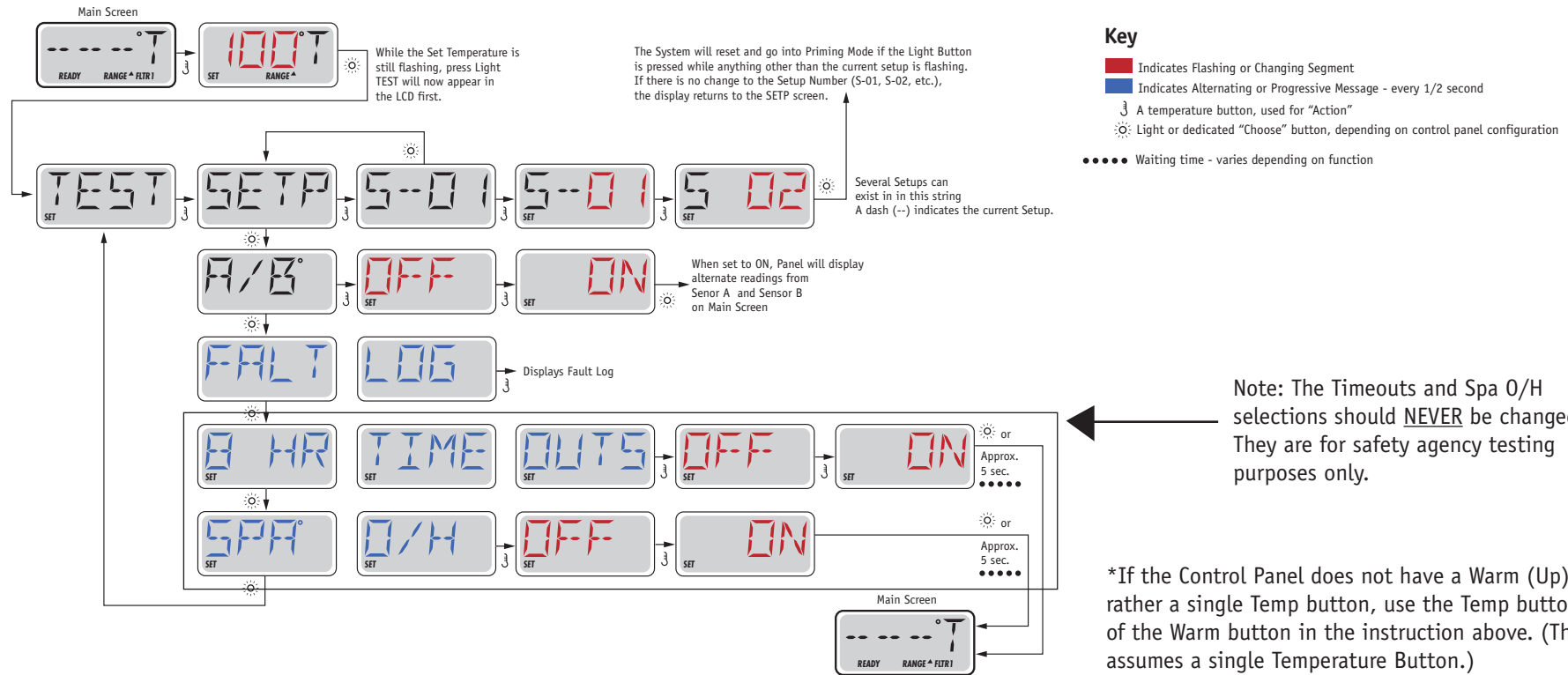
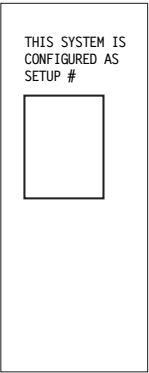

Equipment Expansion

Expansion Features

Control Connection

Relay 1 (J101)

Default

Undefined

Fuse

None

Relay 7/8 (J107)

See Below

30A

2-Speed Pump 2 in Setups 1, 6, 9, 12, 17, 19, 22 & 27

1-Speed Pump 2 (only) in Setups 2, 3, 7, 10, 11, 13, 14, 18, 20, 23, 24 & 28

1-Speed Pump 2 And 1-Speed Pump 4 (With Splitter) in Setups 30-32

Unused in Setups 4, 5, 8, 15, 16, 21, 25, 26 & 29

DIP Switch Functions

Fixed-function DIP Switches

- | | |
|----|--|
| A1 | Test Mode (normally Off). |
| A2 | In "ON" position, add one high-speed pump (or blower) with Heater. |
| A3 | In "ON" position, add two high-speed pumps (or 1 HS Pump and Blower) with Heater. |
| A4 | In "ON" position, add four high-speed pumps (or 3 HS Pumps and Blower) with Heater. |
| A5 | In "ON" position, enables Special Amperage Rule B. See Special Features section under Configuration Options for functionality with your system.
In "OFF" position, enables Special Amperage Rule A. |
| A6 | Persistent memory reset (Used when the spa is powering up to restore factory settings as determined by software configuration). |

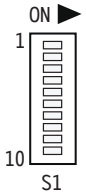

A2, A3, and A4 work in combination to determine the number of high-speed devices and blowers that can run before the heat is disabled. i.e. A2 and A3 in the ON position and A4 in the OFF position will allow the heater to operate with up to 3 high-speed pumps (or two HS Pumps and Blower) running at the same time. Heat is disabled when the fourth high-speed pump or blower is turned on.



Note: A2/A3/A4 all off = No heat with any high-speed pump or blower.

Assignable DIP Switches

- | | |
|----|---|
| A7 | In "ON" position, enables a 5-minute cooldown for some gas heaters (Cooling Time B).
In "OFF" position, enables a 1-minute cooldown for electric heaters (Cooling Time A). |
|----|---|

Undesignated switches are not assigned a function.

Jumper Definitions

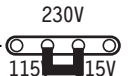
J109	GFCI Test/Trip Enable/Disable Note: <i>This feature must be enabled in software as well.</i>	J109 
J91	Not used on BP1800 board.	
J30	Do Not Use	
J31	Not used on BP1800 board.	
J29	Heater Disable Switch Connection. If J29 is shorted by any means, the heater will not run until J29 is no longer shorted. If J29 is shorted during power-up “J29” will appear on the panel. The message can be dismissed with a button press, and is the only control panel notification of J29 being shorted. No message is displayed if J29 is shorted after power-up, but the heater will not run until J29 is no longer shorted. J29 expects a switch closure (not a voltage) as the command signal. In some areas, a local power company may offer discounts based on voluntary “power shedding” devices that may be installed in conjunction with the spa.	J29 
J25, J26, J27	Not used on BP1800 board. Note: <i>Factory Configured do not change.</i>	
J24	Jumper on center two pins (230V) when heater is running at 240V. Two Jumpers installed; one on left 2 pins and one on right 2 pins (115V) when heater is running at 120V.	J24 

Warning!

Setting DIP switches or jumpers incorrectly may cause abnormal system behavior and/or damage to system components. Refer to Switchbank illustration on Wiring Configuration page for correct settings for this system. Contact Balboa if you require additional configuration pages added to this tech sheet.

Manufactured under one or more of these patents. U.S. Patents: 5332944, 5361215, 5550753, 5559720, 5,883,459, 6253227, 6282370, 6590188, 6976052, 6965815, 7030343, 7,417,834 b2, Canadian Patent: 2342614, Australian patent: 2373248 other patents both foreign and domestic applied for and pending. © Copyright 2009 Balboa Water Group.

Replacement Parts

PCBA:

Main PCBA: G1361-02
Expander PCBA: 59097

HEATER(s):

Plug + Click Heater Kit: G7512 5.5kW 800Inc
G7412 4.0kW 800Inc
Temp Sensor Kit: 53605

CABLES:

N/A

FUSES:

Part Number	Amperage*	Location
30136	30A	F6, F8, F1 (Expander)
26307	2A	F4
26905	0.5A	F3
26904	10A	F2, F7
26976	3.15A	F5

* The amperages shown above are only intended for identifying fuses on our boards. They are not complete descriptions of those fuses. Please use the part numbers at the left to order fuses directly from Balboa.

BP1800 Configuration Options

General Features

Feature	Default
Pump 1 in Filter Cycle (Circ Only)	No
Pump 1 Low Timer	<i>15 Minutes</i>
General Pump Timer	15 Minutes
Blower Timer	15 Minutes
Mister Timer	15 Minutes
Light Timer	240 Minutes
Circ (when enabled)	Programmable + Polling
Cleanup Cycle	<i>30 Minutes</i>
Cleanup as Preference setting	<i>Yes</i>
Ozone	With Heater Pump*
Ozone Suppression	OFF
Pump Purge	60 Seconds
Blower Purge	30 Seconds
Mister Purge	5 Seconds
Purge Type	Serial - Pumps at lowest speed

* The heater Pump can be either a Circ Pump or Pump 1 Low.

BP1800 Configuration Options

Temperature Features

Feature	Default
Temperature Display	°F

All temperatures must be specified in °F. The system converts °F to °C dynamically. If Celsius is required for default settings, choose a desired °C value that (after rounding) corresponds to a Fahrenheit value.

°C	4	5	6	7	8	9	10	11	12	13	14	15	16	17	18	19	20	21	22
°F	39	41	43	45	46	48	50	52	54	55	57	59	61	63	64	66	68	70	72
°C	23	24	25	26	27	28	29	30	31	32	33	34	35	36	37	38	39	40	
°F	73	75	77	79	81	82	84	86	88	90	91	93	95	97	99	100	102	104	

Hi-Range Min. Set Temp	80°F
Hi-Range Max. Set Temp	104°F
Hi-Range Default Temp*	100°F
Lo-Range Min. Set Temp	50°F
Lo-Range Max. Set Temp	99°F
Lo-Range Default Temp*	70°F
Freeze Threshold	44°F
Freeze Type	Rotating - Pumps at Lowest Speed
Temp Lock Type	Temp + Settings

*May be changed by end-user (if enabled)

Manufactured under one or more of these patents. U.S. Patents: 5332944, 5361215, 5550753, 5559720, 5,883,459, 6253227, 6282370, 6590188, 6976052, 6965815, 7030343, 7,417,834 b2, Canadian Patent: 2342614, Australian patent: 2373248 other patents both foreign and domestic applied for and pending. © Copyright 2009 Balboa Water Group.

BP1800 Configuration Options

Time Features

Feature	Default
Time Format*	12 Hour
Filter 1 Start Hour*	20:00 (8:00 PM)
Filter 1 Duration*	2 Hours
Filter Cycle 2 Default*	OFF
Filter 2 Start Hour*	08:00 (8:00 AM)
Filter 2 Duration*	15 Minutes
Light Cycle	Disabled
Light Cycle Default*	OFF
Light Cycle Start Hour*	21:00 (9:00 PM)
Light Cycle Duration*	15 Minutes
Cooling Time A	1 Minute
Cooling Time B	5 Minutes

**May be changed by end-user (if enabled)*

Manufactured under one or more of these patents. U.S. Patents: 5332944, 5361215, 5550753, 5559720, 5,883,459, 6253227, 6282370, 6590188, 6976052, 6965815, 7030343, 7,417,834 b2, Canadian Patent: 2342614, Australian patent: 2373248 other patents both foreign and domestic applied for and pending. © Copyright 2009 Balboa Water Group.

BP1800 Configuration Options

Reminder Features

Feature	Default
Reminders Shown*	<i>Yes</i>
Check pH	<i>OFF</i>
Check Sanitizer	<i>OFF</i>
Clean Filter	30 Days
Test GFCI	<i>65 Days</i>
Drain Water	<i>100 Days</i>
Change Cartridge	OFF
Clean Cover	<i>OFF</i>
Treat Wood	<i>OFF</i>
Change Filter	365 Days

**May be changed by end-user (if enabled)*

Manufactured under one or more of these patents. U.S. Patents: 5332944, 5361215, 5550753, 5559720, 5,883,459, 6253227, 6282370, 6590188, 6976052, 6965815, 7030343, 7,417,834 b2, Canadian Patent: 2342614, Australian patent: 2373248 other patents both foreign and domestic applied for and pending. © Copyright 2009 Balboa Water Group.

BP1800 Configuration Options

Special Features

Feature

Default

Special Amperage Rule A

MicroSilk® immediately turns OFF pumps in Setups 22-29; No Limitation in other Setups

Special Amperage Rule B

MicroSilk® immediately turns OFF pumps in Setups 22-29; 3 high-speed pumps maximum in Setups 30-32;
2 high-speed pumps maximum and blower suppressed when 2 pumps are on high-speed, in other Setups

Drain Mode

Disabled

Demo Mode

Disabled

GFCI Trip

Enabled

Automatic GFCI Test

Disabled

Ozone Slaved to Heater Pump

Yes in circ setups
No in non-circ setups

Dual Voltage Heater

Always Input Voltage

Safety Suction

Disabled

TP900 Panel Configuration

Button Layout Table

Button #	Pump 3 AND Pump 4 Setups 30-32	Pump 3 (no Pump 4) Setups 9-11, 17 & 18	Blower + Pump 2 Setups 1-3, 6 & 7	Blower (no Pump 2) Setups 4, 5 & 8	MicroSilk® + Pump 2 Setups 22-24, 27 & 28	MicroSilk® (no Pump 2) Setups 25, 26 & 29	Pump 2 (no P3/BL/MS) Setup 12-14, 19 & 20	Pump 1 (no P2/BL/MS) Setup 15, 16 & 21
1	N/A	N/A	N/A	N/A	N/A	N/A	N/A	N/A
2	Jets 1	Jets 1	Jets 1	Jets 1	Jets 1	Jets 1	Jets 1	Jets 1
3	Jets 2	Jets 2	Jets 2	Blower	Jets 2	MicroSilk®	Jets 2	Light 1
4	Jets 3	Jets 3	Blower	Light 1	MicroSilk®	Light 1	Light 1	Invert
5	Jets 4	Light 1	Light 1	Invert	Blower	Invert	Invert	(Circ Icon)
6	Light 1	Invert	Invert	(Circ Icon)	Light 1	(Circ Icon)	(Circ Icon)	Undefined
7	Invert	(Circ Icon)	(Circ Icon)	Undefined	Invert	Undefined	Undefined	Undefined
8	(Circ Icon*)	Undefined	Undefined	Undefined	(Circ Icon)	Undefined	Undefined	Undefined
9	Undefined	Undefined	Undefined	Undefined	Undefined	Undefined	Undefined	Undefined
10	Undefined	Undefined	Undefined	Undefined	Undefined	Undefined	Undefined	Undefined
11	N/A	N/A	N/A	N/A	N/A	N/A	N/A	N/A
12	N/A	N/A	N/A	N/A	N/A	N/A	N/A	N/A
13	Jets 1	Jets 1	Jets 1	Jets 1	Jets 1	Jets 1	Jets 1	Jets 1
14	Jets 2	Jets 2	Jets 2	Blower	Jets 2	Undefined	Jets 2	Undefined
15	Jets 3	Jets 3	Blower	Light	MicroSilk®	MicroSilk®	Light	Light
16	Light	Light	Light	Invert	Light	Light	Invert	Invert

* A Circ Icon will appear in Circ Setups 1–5, 9-16, 22-26, 30 & 31; it will not appear in non-Circ Setups 6–8, 17-21, 27-29 & 32.

TP900 Panel Configuration

Button #
1
2
3
4
5
6
7
8
9
10
11
12
13
14
15
16

Spa Screen

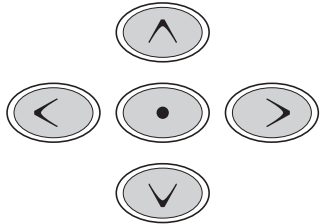
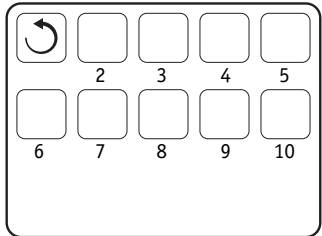

Shortcuts Screen

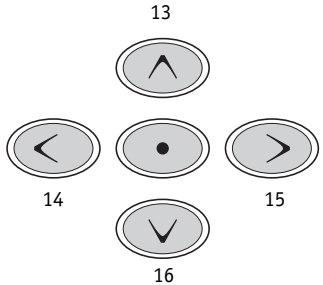
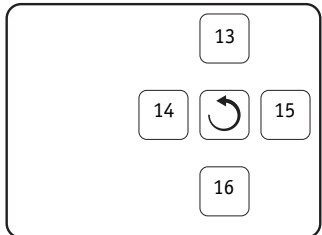

Manufactured under one or more of these patents. U.S. Patents: 5332944, 5361215, 5550753, 5559720, 5,883,459, 6253227, 6282370, 6590188, 6976052, 6965815, 7030343, 7,417,834 b2, Canadian Patent: 2342614, Australian patent: 2373248 other patents both foreign and domestic applied for and pending. © Copyright 2009 Balboa Water Group.

TP800 Panel Configuration

Button Layout Table

Feature #	Pump 3 AND Pump 4 Setups 30-32	Pump 3 (no Pump 4) Setups 9-11, 17 & 18	Blower + Pump 2 Setups 1-3, 6 & 7	Blower (no Pump 2) Setups 4, 5 & 8	MicroSilk® + Pump 2 Setups 22-24, 27 & 28	MicroSilk® (no Pump 2) Setups 25, 26 & 29	Pump 2 (no P3/BL/MS) Setup 12-14, 19 & 20	Pump 1 (no P2/BL/MS) Setup 15, 16 & 21
A1	N/A	N/A	N/A	N/A	N/A	N/A	N/A	N/A
A2	Jets 1	Jets 1	Jets 1	Jets 1	Jets 1	Jets 1	Jets 1	Jets 1
A3	Jets 2	Jets 2	Jets 2	Blower	Jets 2	MicroSilk®	Jets 2	Light 1
A4	Jets 3	Jets 3	Blower	Light 1	MicroSilk®	Light 1	Light 1	Invert
A5	Jets 4	Light 1	Light 1	Invert	Blower	Invert	Invert	(Circ Icon)
A6	Light 1	Invert	Invert	(Circ Icon)	Light 1	(Circ Icon)	(Circ Icon)	Undefined
A7	Invert	(Circ Icon)	(Circ Icon)	Undefined	Invert	Undefined	Undefined	Undefined
A8	(Circ Icon*)	Undefined	Undefined	Undefined	(Circ Icon)	Undefined	Undefined	Undefined
A9	Undefined	Undefined	Undefined	Undefined	Undefined	Undefined	Undefined	Undefined
A10	Undefined	Undefined	Undefined	Undefined	Undefined	Undefined	Undefined	Undefined
A11	N/A	N/A	N/A	N/A	N/A	N/A	N/A	N/A
A12	N/A	N/A	N/A	N/A	N/A	N/A	N/A	N/A
A13	Jets 1	Undefined	Undefined	Undefined	Undefined	Undefined	Undefined	Undefined
A14	Jets 2	Undefined	Undefined	Undefined	Undefined	Undefined	Undefined	Undefined
A15	Jets 3	Undefined	Undefined	Undefined	Undefined	Undefined	Undefined	Undefined
A16	Jets 4	Undefined	Undefined	Undefined	Undefined	Undefined	Undefined	Undefined
B1	Jets 1	Jets 1	Jets 1	Jets 1	Jets 1	Jets 1	Jets 1	Jets 1
B2	Jets 2	Jets 2	Jets 2	Blower	Jets 2	Undefined	Jets 2	Undefined
B3	Jets 3	Jets 3	Blower	Undefined	MicroSilk®	MicroSilk®	Undefined	Undefined
B4	Light	Light	Light	Light	Light	Light	Light	Light

* A Circ Icon will appear in Circ Setups 1–5, 9-16, 22-26, 30 & 31; it will not appear in non-Circ Setups 6–8, 17-21, 27-29 & 32.

TP800 Panel Configuration

Spa Screen

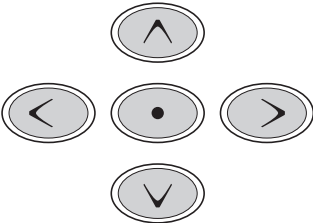
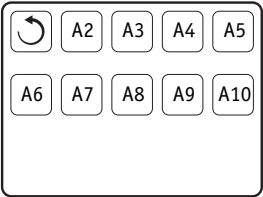
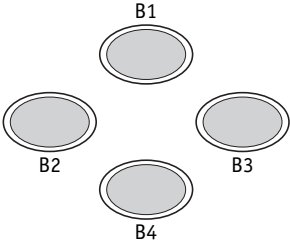

Shortcuts Screen

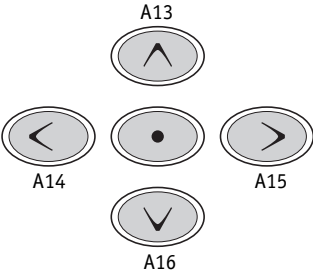
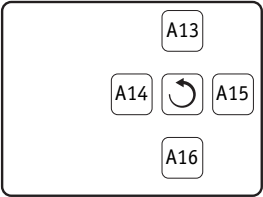
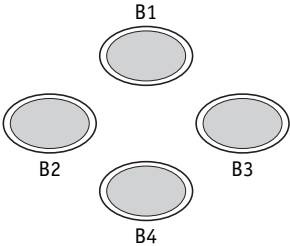

Note: Buttons 11 and 12 are not used in this configuration.
Button 1 is fixed.

TP600 Panel Configuration

Button Layout Table

Button #	Pump 3 AND Pump 4 Setups 30-32	Pump 3 (no Pump 4) Setups 9-11, 17 & 18	Blower + Pump 2 Setups 1-3, 6 & 7	Blower (no Pump 2) Setups 4, 5 & 8	MicroSilk® + Pump 2 Setups 22-24, 27 & 28	MicroSilk® (no Pump 2) Setups 25, 26 & 29	Pump 2 (no P3/BL/MS) Setup 12-14, 19 & 20	Pump 1 (no P2/BL/MS) Setup 15, 16 & 21
1	Jets 1	Jets 1	Jets 1	Jets 1	Jets 1	Jets 1	Jets 1	Jets 1
2	Jets 2	Jets 2	Jets 2	Blower	Jets 2	MicroSilk®	Jets 2	Unused
3	Jets 3	Jets 3	Blower	Invert	MicroSilk®	Invert	Invert	Invert
4	Temperature	Up	Up	Up	Up	Up	Up	Up
5	Light 1	Light 1	Light 1	Light 1	Light 1	Light 1	Light 1	Light 1
6	Jets 4	Down	Down	Down	Down	Down	Down	Down
LED 1	Jets 1	Jets 1	Jets 1	Jets 1	Jets 1	Jets 1	Jets 1	Jets 1
LED 2	Jets 2	Jets 2	Jets 2	Blower	Jets 2	MicroSilk®	Jets 2	Unused
LED 3	Light 1	Light 1	Light 1	Light 1	Light 1	Light 1	Light 1	Light 1
LED 4	Heat On	Heat On	Heat On	Heat On	Heat On	Heat On	Heat On	Heat On
Generic Overlay	13579	12762	12762	12101	13142	12740	12198*	13635*

* Overlay 12101 can also be used



TP600

55676-XX - No Overlay

Manufactured under one or more of these patents. U.S. Patents: 5332944, 5361215, 5550753, 5559720, 5,883,459, 6253227, 6282370, 6590188, 6976052, 6965815, 7030343, 7,417,834 b2, Canadian Patent: 2342614, Australian patent: 2373248 other patents both foreign and domestic applied for and pending. © Copyright 2009 Balboa Water Group.

BALBOA
water group

TP400/TP200 Panel Configuration

Button Layout Table for TP400T/TP200T TP400T/TP200T is not supported in Setups 1-3, 6, 7, 9-11, 17, 18, 22-24, 27, 28 & 30-32.

Button #	Setups 4, 5, & 8	Setups 12-14, 19 & 20	Setups 15, 16 & 21	Setups 25, 26 & 29
1	Temperature	Temperature	Temperature	Temperature
2	Jets 1	Jets 1	Jets 1	Jets 1
3	Light 1	Light 1	Light 1	Light 1
4	Blower	Jets 2	Undefined	MicroSilk®
LED 1	Heater ON	Heater ON	Heater ON	Heater ON
LED 2	Jets 1 ON	Jets 1 ON	Jets 1 ON	Jets 1 ON
LED 3	Light ON	Light ON	Light ON	Light ON
LED 4	Blower ON	Jets 2 ON	Undefined	MicroSilk® ON

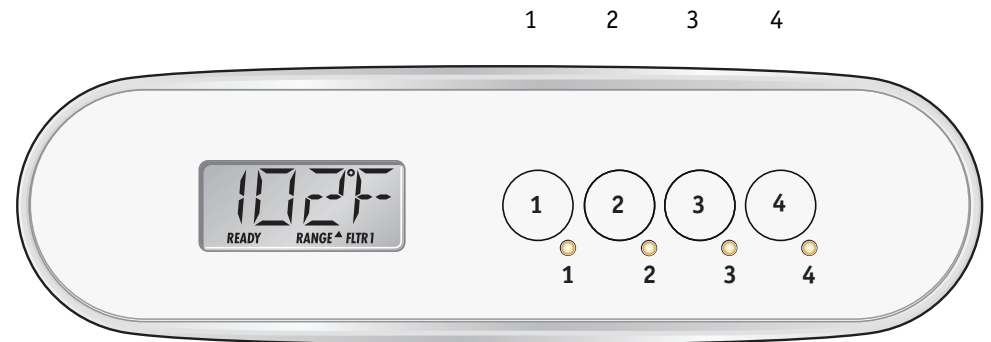

1 2 3 4
TP400T US

50380-XX includes overlay PN 12511

Button Layout Table for TP400W/TP200W

Button #	All Setups
1	Up
2	Down
3	Light 1
4	Jets 1
LED 1	Heater ON
LED 2	Undefined
LED 3	Light ON
LED 4	Jets 1 ON

TP400W/TP200W is supported in Setups 15, 16 & 21 only.



TP200T

57281-XX with no overlay

57282-XX includes overlay PN 17325

TP400W US

50384-XX includes overlay PN 12510

TP200W

57290-XX with no overlay

57283-XX includes overlay PN 17374

BP1800 Configuration Options

Auxiliary Panel Features on Bank 1*

Feature	Default
Aux Button A1	Jets 1
Aux Button A2	Jets 2
Aux Button A3	<i>Jets 3 in Setups 9-11, 17, 18 & 30-32; MicroSilk® in Setups 22-29; Blower in all other Setups</i>
Aux Button A4	Light

*Bank 1 consists of J5 on the Main Circuit Board.

Buttons that are assigned to equipment that is not defined in a Setup will not do anything in that Setup.

Aux Connection Splitter PN 25257 may be required.

BP1800 Configuration Options

Auxiliary Panel Features

AX10 Panels on Bank 1*

A1, AX10A1	No O/L	52803
A2, AX10A2	No O/L	52804
A3, AX10A3	No O/L	52805
A4, AX10A4	No O/L	52806

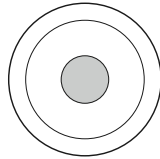

Call Customer Service for additional information about Auxiliary Panels.

*Bank 1 consists of J5 on the Main Circuit Board.

Aux Connection Splitter PN 25257 may be required.

AX20

AX20 A1A2	No O/L	52800
AX20 A1A3	No O/L	52801
AX20 A1A4	No O/L	52802

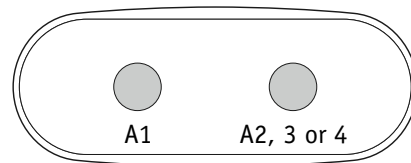

AX20 Auxiliary Panel plugged into Bank 1 will operate A1 + A2, A3 or A4.

AX40

AX40	No O/L	52799
------	--------	-------

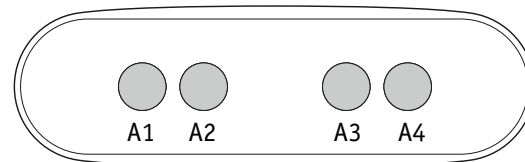

AX40 Auxiliary Panel plugged into Bank 1 will operate A1 + A2, A3 and A4.