

BP501G2 Tech Sheet

Customer: Balboa Water Group

Part Number: 56480-02 5.5kW 800 Incoloy
56481-02 5.5kW 825 Incoloy
56482-02 5.5kW Titanium

Custom Box Overlay
Box Overlay Part Number N/A

UL System Model: BP501-BP501G2-BU
Software Version ID: M100_201 V36.0
Software Version: 36.0
File Name: BP501_36.0_BP501G2.hex
Configuration Signature: FC2144E4

Eng. Project Number: 4776

Control Panels (See later pages for more information):

spaTouch™2 Any version (version 2.0 or later required for bba™2 fully integrated functionality)
Icon spaTouch™ Any version (version 3.36 or later required for bba™2 fully integrated functionality)
Menued spaTouch™ Any version (version 2.8 or later required for bba™2 integrated functionality)
TP800 Version 3.1 and later (Version 3.13 or later required for bba™; version 4.11 or later required for bba™2 integrated functionality)
TP600 Version 2.7 and later
TP400T US Version 2.7 and later (TP400T CE may be used)
TP400W US Version 2.7 and later (TP400W CE may be used)



Manufactured under one or more of these patents. U.S. Patents: 5332944, 5361215, 5550753, 5559720, 5,883,459, 6253227, 6282370, 6590188, 6976052, 6965815, 7030343, 7,417,834 b2, Canadian Patent: 2342614, Australian patent: 2373248 other patents both foreign and domestic applied for and pending. © Copyright 2009 Balboa Water Group.

BALBOA
water group

System Revision History

Part #	EPN	Date	Originator	Changes Made
56480 56481 56482	4109	07-26-13	BWG	BP501G2 initial draft
56480-01 56481-01 56482-01	4132	10-15-13	BWG	Updated to latest software version. Adds GFCI Trip (but not GFCI Automatic Test).
"	4132	03-12-14	BWG	Updated to latest software version, adding topside-intergrated bba™ support. Released to production.
56480-02 56481-02 56482-02	4776	10-07-16	BWG	Updated to latest software version, adding topside-intergrated bba™2 support. Released to production.

bba™ & bba™2 (Balboa Bluetooth Amp) connection is documented seperately.

bba™ is only integrated into graphic display panels (TP800, TP900 and spaTouch™). With TP600 the Aux button operation of bba™ must be used.

bba™2 is only integrated into graphic display panels (TP800, TP900 and spaTouch™). bba™2 does not support Aux button operation.

Basic Functions Setup 1 - 3

Power Requirements:

240VAC, 50/60Hz*, 48A, Class A GFCI-protected service (Circuit Breaker = 60A max.),
4 wires [hot, hot, neutral, ground]

120/240VAC, 50/60Hz*, 16/40A, Class A GFCI-protected service (Circuit Breaker = 20 /50A max.) - Setup 3 ONLY,
3 or 4 wires [hot, hot (optional), neutral, ground].

*BP systems automatically detect 50Hz vs 60Hz.

System Outputs:

Pump 1	240VAC	2-Speed	12A max	15-minute timer
Pump 2	240VAC	1-Speed Used in Setup 1 only	12A max	15-minute timer
Blower	240VAC	1-Speed Used in Setup 2 only	4A max	15-minute timer
Circ Pump	240VAC*	1-Speed This is the heater pump Must deliver 20 GPM through heater	2A max	Programmable Filtration Cycles + Polling
Ozone	240VAC*		.5A max	Slaved to Circ Pump
Spa Light	10VAC	On/Off	1A max	240-minute timer.
A/V (Stereo)	120VAC	Hot	4A max	Always on
Heater	5.5kW @ 240VAC max			

*Circ Pump and Ozone must be the same voltage.

With 120VAC power input (for Setup 3 only), Circ pump and Ozone must be set to 120VAC by moving wires attached to J50 and J51 to area 1 (Neutral).

HiPot Testing Note:

Disconnect slip terminal with green wires from J52 prior to performing HiPot test. Failure to disconnect may cause a false failure of the test. Reconnect terminal to J52 after successful completion of HiPot test.

Hardware Setup

Wiring Diagram

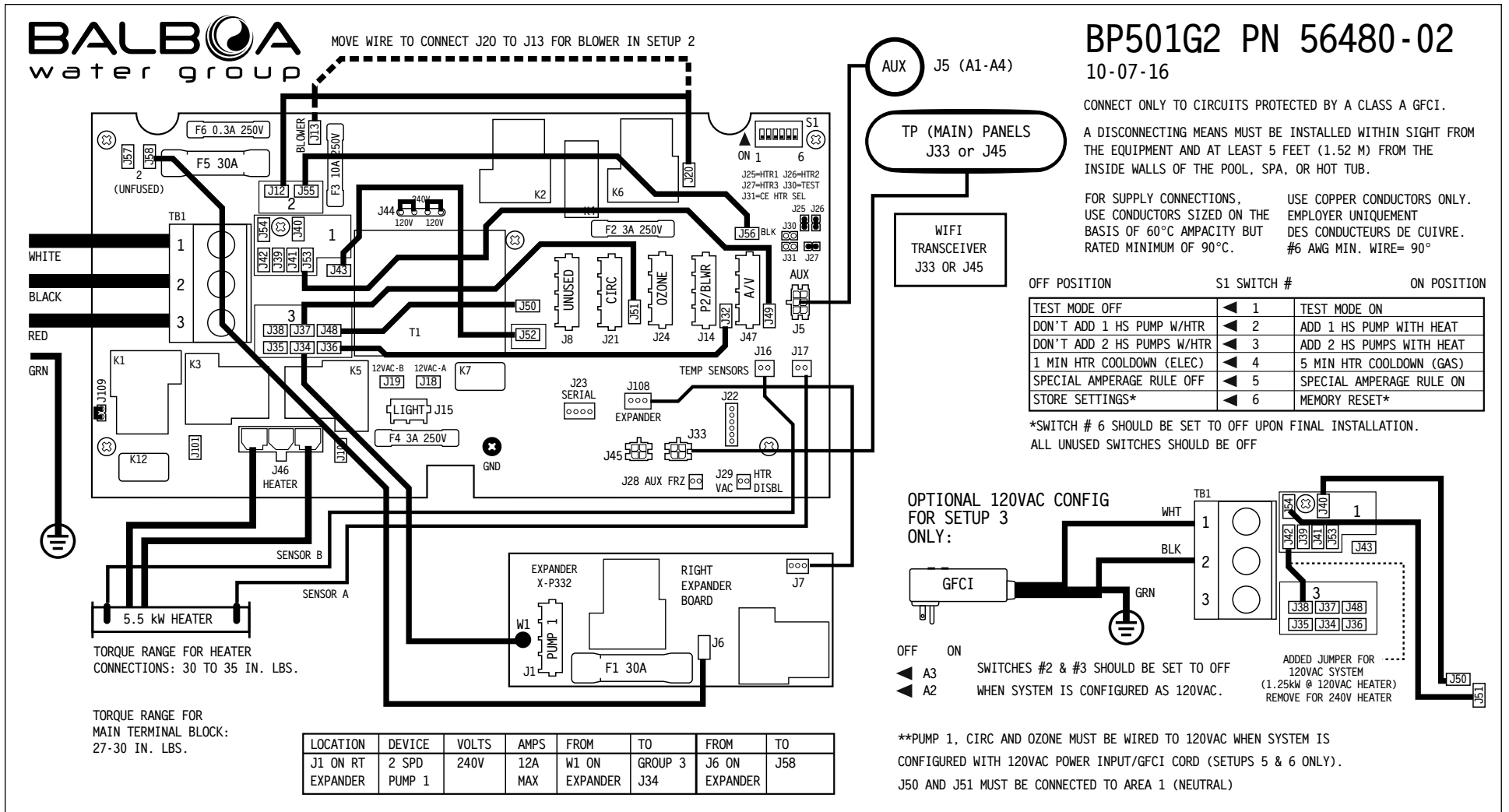

Setup Reference Table

Setup #	Circ Pump	Pump 1	Pump 2	Pump 3	Blower	Temp Scale
1	Programmable Filtration + Polling	2-Speed	1-Speed	None	None	°F
2	Programmable Filtration + Polling	2-Speed	None	None	1-Speed	°F
3	Programmable Filtration + Polling	2-Speed	None	None	None	°F

System (and any replacement board) is shipped in Setup 1

As shown on additional wiring diagram section:

INSTEAD OF SETUP #1, THIS SYSTEM IS CONFIGURED IN SETUP #:	SETUP #	CIRC PUMP	PUMP 1	PUMP 2	PUMP 3	BLOWER	TEMP SCALE
	1	FILTERS + POLLING	2-SPEED	1-SPEED	NONE	NONE	°F
	2	FILTERS + POLLING	2-SPEED	NONE	NONE	1-SPEED	°F
	3	FILTERS + POLLING	2-SPEED	NONE	NONE	NONE	°F

LOCATION	DEVICE	VOLTS	MAX AMPS	FROM	TO
J8	N/A			J50	J48-AREA 3
J14	1-SP PUMP 2	240V	10A MAX	J32	J36-AREA 3
J14	BLOWER OPT	240V	4A MAX	J32	J36-AREA 3
J15	SPA LIGHT	10V	1A		
J21	CIRC	240V**	2A MAX		
J24	OZONE	240V**	1A		
	CIRC AND OZONE LINE 1 CONNECTION			J51	J37-AREA 3
J47	TV / AV	120V	2A	J49	J53-AREA 1
J46	HEATER	240V	5.5 kW		

Changing Software Setups with TP800 / TP900 / spaTouch™ Menued Panel

Test Menu Access (S1, Switch 1 ON) *Service Technician ONLY.*

DANGER! HIGH VOLTAGE WILL BE ACCESSIBLE! SERVICE TECHNICIAN ONLY!

While the system is running, move DIP Switch 1 (on S1 on the Main circuit board) to ON.
The system will enter Test Mode.
Moving DIP Switch 1 to OFF will exit Test Mode.

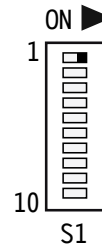

Software Setups

Under the TEST Menu, the Setup screen will allow changing the Setup from 1 to any number established by the Manufacturer.
Changing the Setup may require wiring changes as well.

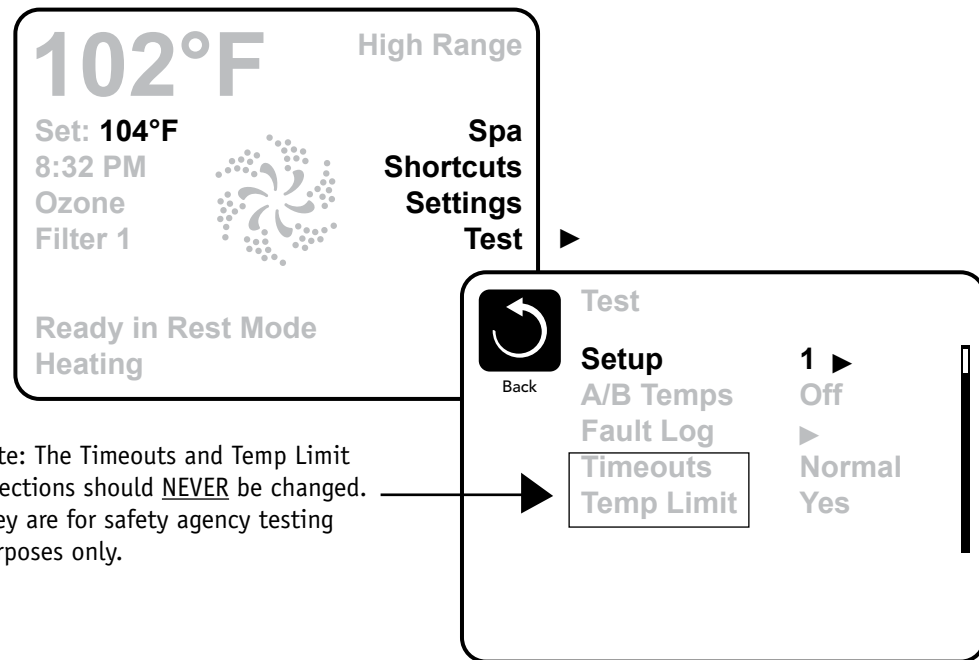

Changing Software Setups with TP600 / TP400

Test Menu Access (S1, Switch 1 ON) *Service Technician ONLY.*

DANGER! HIGH VOLTAGE WILL BE ACCESSIBLE! SERVICE TECHNICIAN ONLY!

While the system is running, move DIP Switch 1 (on S1 on the Main circuit board) to ON. The system will enter Test Mode. Moving DIP Switch 1 to OFF will exit Test Mode.

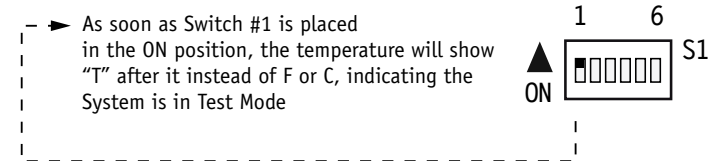

Software Setups

Under the TEST Menu, the Setup screen will allow changing the Setup from 1 to any number established by the Manufacturer. Changing the Setup may require wiring changes as well.

You will have 1 minute to complete the setup change after you manually exit Priming Mode. (Once familiar with the process, the Setup change should take less than 15 seconds.)



When the panel displays RUN PMPS PURG AIR, press any Temperature button ONCE to exit Priming Mode. You should see "---T" where the T indicates the system is in Test Mode.

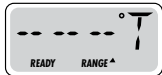

Continued on Next Page.

Changing Software Setups with TP600 / TP400 Continued

Again, **You will have 1 minute** to complete the setup change after you manually exit Priming Mode.

Immediately after exiting Priming Mode, press this sequence of buttons: Warm*, Light, Warm, Warm, Warm, Warm. Continue to press Warm until the display shows the Setup Number (S-01, S-02, etc.) you want to switch to. When the correct setup number is showing, press Light once, and the system will reset, using the newly-selected Setup from that point on.

Move DIP Switch 1 to the OFF position to take the spa out of Test Mode. °F or °C will replace °T.

Using a permanent marker, write the Setup number on the Setup label mounted inside the system lid (right). This is very important to any service person in the future who may need to replace a circuit board or system and needs to change the Setup on a replacement part while in the field.

NOTE: Changing the Setup may require wiring changes as well - refer to the wiring diagram or wiring diagram addendum.

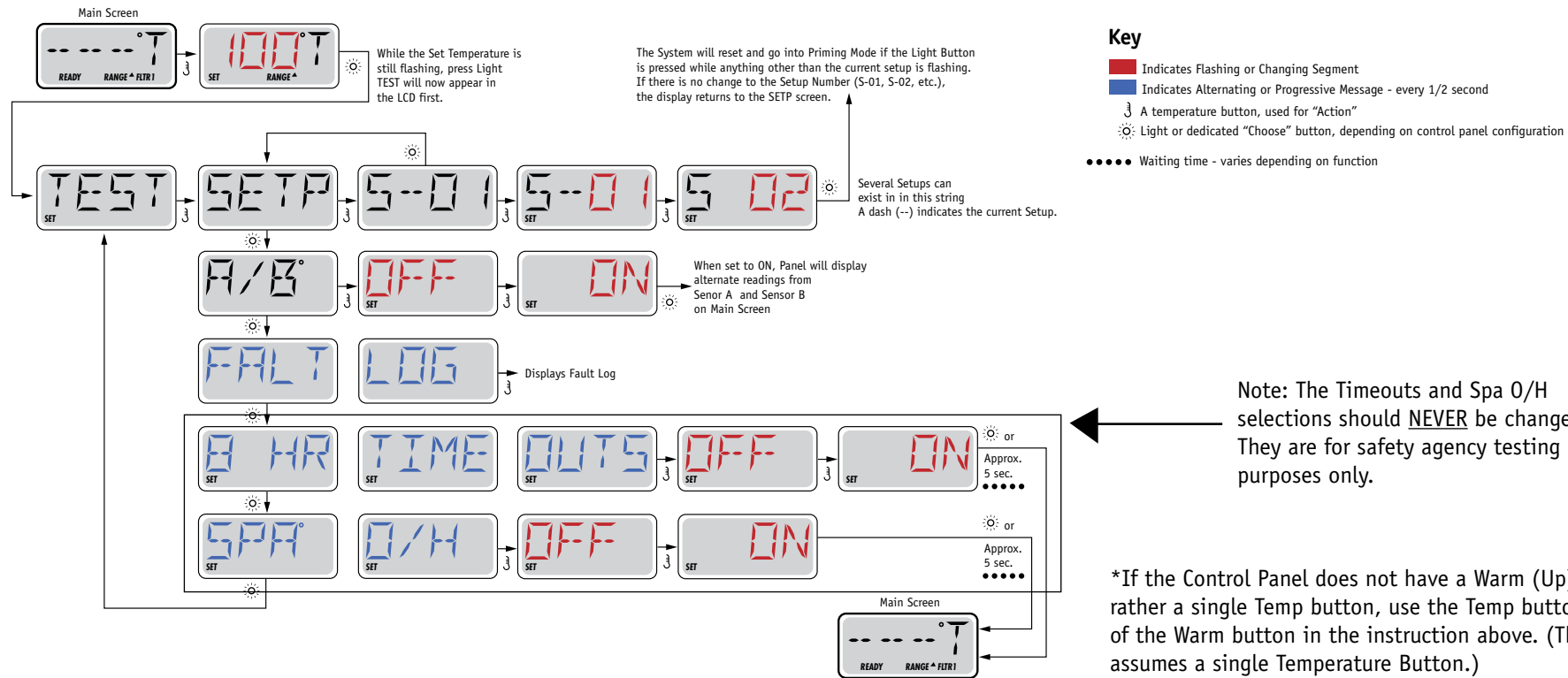
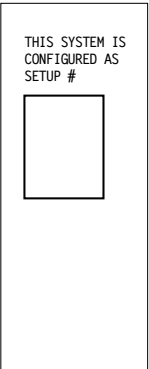

Manufactured under one or more of these patents. U.S. Patents: 5332944, 5361215, 5550753, 5559720, 5,883,459, 6253227, 6282370, 6590188, 6976052, 6965815, 7030343, 7,417,834 b2, Canadian Patent: 2342614, Australian patent: 2373248 other patents both foreign and domestic applied for and pending. © Copyright 2009 Balboa Water Group.



Equipment Expansion

Expansion Features

Control Connection

Relay 1/2 (J108)

Default

2-Speed Pump 1

Fuse

30A

DIP Switch Functions

Fixed-function DIP Switches

- A1 Test Mode (normally Off).
- A2 In "ON" position, add one high-speed pump (or blower) with Heater.
- A3 In "ON" position, add two high-speed pumps (or 1 HS Pump and Blower) with Heater.
- A5 In "ON" position, enables Special Amperage Rule B. See Special Features section under Configuration Options for functionality with your system.
In "OFF" position, enables Special Amperage Rule A.
- A6 Persistent memory reset (Used when the spa is powering up to restore factory settings as determined by software configuration).

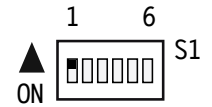

A2 and A3 work in combination to determine the number of high-speed devices and blowers that can run before the heat is disabled. i.e. A2 and A3 in the ON position will allow the heater to operate with up to 3 high-speed pumps (or two HS Pumps and Blower) running at the same time. Heat is disabled when the fourth high-speed pump or blower is turned on.





Note: A2/A3 all off = No heat with any high-speed pump or blower.

Assignable DIP Switches

- A4 In "ON" position, enables a 5-minute cooldown for some gas heaters (Cooling Time B).
In "OFF" position, enables a 1-minute cooldown for electric heaters (Cooling Time A).

Undesignated switches are not assigned a function.

Jumper Definitions

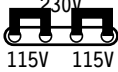
J109	GFCI Test/Trip Enable/Disable Note: <i>This feature must be enabled in software as well.</i>	J109 
J30	Do Not Use	
J31	Non Applicable on UL models <i>(Used on CE models only)</i>	J31 
J29	Heater Disable Switch Connection. If J29 is shorted by any means, the heater will not run until J29 is no longer shorted. If J29 is shorted during power-up “J29” will appear on the panel. The message can be dismissed with a button press, and is the only control panel notification of J29 being shorted. No message is displayed if J29 is shorted after power-up, but the heater will not run until J29 is no longer shorted. J29 expects a switch closure (not a voltage) as the command signal. In some areas, a local power company may offer discounts based on voluntary “power shedding” devices that may be installed in conjunction with the spa.	J29 
J25, J26, J27	Heater Type Settings. Note: <i>Factory Configured do not change.</i>	
J44	Jumper on center two pins (230V) when no neutral wire is used (240V-dedicated). Two Jumpers installed; one on left 2 pins and one on right 2 pins (115V) when neutral wire is used.	

Warning!

Setting DIP switches or jumpers incorrectly may cause abnormal system behavior and/or damage to system components.
Refer to Switchbank illustration on Wiring Configuration page for correct settings for this system.
Contact Balboa if you require additional configuration pages added to this tech sheet.

Replacement Parts

PCBA:

Main PCBA: 56483-02
Expander PCBA: 55137

HEATER(s):

Plug + Click Heater Kit: 58306 5.5kW 800Inc
58307 5.5kW 825Inc
58308 5.5kW Titanium
Temp Sensor: Kit 53605

CABLES:

21302 Jumper 120V Heater

FUSES:

Part Number	Amperage	Location
30136	30A	F5, F1 (Expander)
20600	3A	F2, F4
21581	3/10A	F6
30122	10A	F3

BP501 Configuration Options

General Features

Feature	Default	
Pump 1 in Filter Cycle (Circ Only)	No	
Pump 1 Low Timer	<i>30 Minutes</i>	Applies in non-circ Setups (configurations) only
General Pump Timer	15 Minutes	
Blower Timer	15 Minutes	
Mister Timer	15 Minutes	
Light Timer	240 Minutes	
Circ (when enabled)	Programmable + Polling	
Cleanup Cycle	<i>30 Minutes</i>	
Cleanup as Preference setting	<i>Yes</i>	
Ozone	With Heater Pump*	
Ozone Suppression	OFF	
Pump Purge	60 Seconds	
Blower Purge	30 Seconds	
Mister Purge	5 Seconds	
Purge Type	Serial - Pumps at lowest speed	

* The heater Pump can be either a Circ Pump or Pump 1 Low.

BP501 Configuration Options

Temperature Features

Feature	Default
Temperature Display	°F

All temperatures must be specified in °F. The system converts °F to °C dynamically. If Celsius is required for default settings, choose a desired °C value that (after rounding) corresponds to a Fahrenheit value.

°C	4	5	6	7	8	9	10	11	12	13	14	15	16	17	18	19	20	21	22
°F	39	41	43	45	46	48	50	52	54	55	57	59	61	63	64	66	68	70	72
°C	23	24	25	26	27	28	29	30	31	32	33	34	35	36	37	38	39	40	
°F	73	75	77	79	81	82	84	86	88	90	91	93	95	97	99	100	102	104	

Hi-Range Min. Set Temp	80°F
Hi-Range Max. Set Temp	104°F
Hi-Range Default Temp*	100°F
Lo-Range Min. Set Temp	50°F
Lo-Range Max. Set Temp	99°F
Lo-Range Default Temp*	70°F
Freeze Threshold	44°F
Freeze Type	Rotating - Pumps at Lowest Speed
Temp Lock Type	Temp + Settings

**May be changed by end-user (if enabled)*

Manufactured under one or more of these patents. U.S. Patents: 5332944, 5361215, 5550753, 5559720, 5,883,459, 6253227, 6282370, 6590188, 6976052, 6965815, 7030343, 7,417,834 b2, Canadian Patent: 2342614, Australian patent: 2373248 other patents both foreign and domestic applied for and pending. © Copyright 2009 Balboa Water Group.

BP501 Configuration Options

Time Features

Feature	Default
Time Format*	12 Hour
Filter 1 Start Hour*	20:00 (8:00 PM)
Filter 1 Duration*	2 Hours
Filter Cycle 2 Default*	OFF
Filter 2 Start Hour*	08:00 (8:00 AM)
Filter 2 Duration*	15 Minutes
Light Cycle	Disabled
Light Cycle Default*	OFF
Light Cycle Start Hour*	21:00 (9:00 PM)
Light Cycle Duration*	15 Minutes
Cooling Time A	1 Minute
Cooling Time B	5 Minutes

**May be changed by end-user (if enabled)*

Manufactured under one or more of these patents. U.S. Patents: 5332944, 5361215, 5550753, 5559720, 5,883,459, 6253227, 6282370, 6590188, 6976052, 6965815, 7030343, 7,417,834 b2, Canadian Patent: 2342614, Australian patent: 2373248 other patents both foreign and domestic applied for and pending. © Copyright 2009 Balboa Water Group.

BP501 Configuration Options

Reminder Features

Feature	Default
Reminders Shown*	<i>Yes</i>
Check pH	<i>OFF</i>
Check Sanitizer	<i>OFF</i>
Clean Filter	30 Days
Test GFCI	<i>65 Days</i>
Drain Water	<i>100 Days</i>
Change Cartridge	OFF
Clean Cover	<i>OFF</i>
Treat Wood	<i>OFF</i>
Change Filter	365 Days

**May be changed by end-user (if enabled)*

Manufactured under one or more of these patents. U.S. Patents: 5332944, 5361215, 5550753, 5559720, 5,883,459, 6253227, 6282370, 6590188, 6976052, 6965815, 7030343, 7,417,834 b2, Canadian Patent: 2342614, Australian patent: 2373248 other patents both foreign and domestic applied for and pending. © Copyright 2009 Balboa Water Group.

BP501 Configuration Options

Special Features

Feature

Default

Special Amperage Rule A

No Limitation

Special Amperage Rule B

No Limitation

Drain Mode

Disabled

Demo Mode

Disabled

GFCI Trip

Enabled

Automatic GFCI Test

Disabled

Ozone Slaved to Heater Pump

Yes

Dual Voltage Heater

Always Input Voltage

Safety Suction

Disabled

TP800 Panel Configuration

Button Layout Table

Feature #	Setup 1	Setup 2	Setup 3
A1	N/A	N/A	N/A
A2	Jets 1	Jets 1	Jets 1
A3	Jets 2	Blower	Light 1
A4	Light 1	Light 1	Invert
A5	Invert	Invert	(Circ Icon)
A6	(Circ Icon)	(Circ Icon)	Undefined
A7	Undefined	Undefined	Undefined
A8	Undefined	Undefined	Undefined
A9	Undefined	Undefined	Undefined
A10	Undefined	Undefined	Undefined
A11	N/A	N/A	N/A
A12	N/A	N/A	N/A
A13	Undefined	Undefined	Undefined
A14	Undefined	Undefined	Undefined
A15	Undefined	Undefined	Undefined
A16	Undefined	Undefined	Undefined
B1	Jets 1	Jets 1	Jets 1
B2	Undefined	Undefined	Undefined
B3	Jets 2	Blower	Undefined
B4	Light 1	Light 1	Light 1

TP800 Panel Configuration

Spa Screen

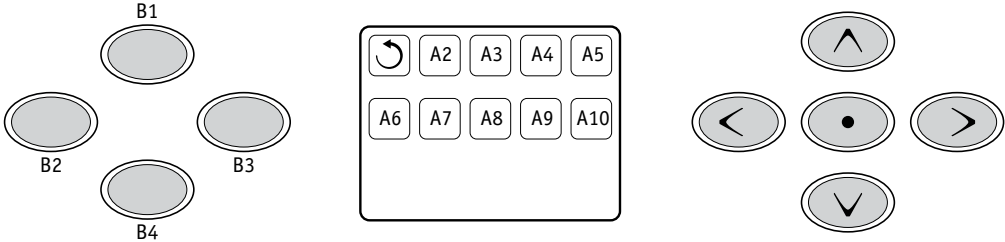

Note: Button B2 is ALWAYS unused on TP800 when used with this sytsem. A custom overlay will be required.

Shortcuts Screen

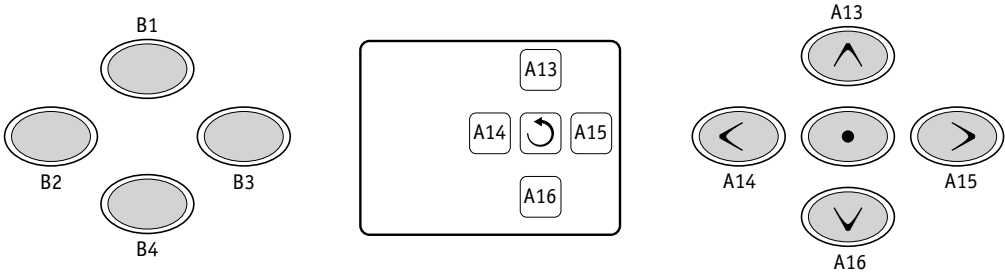

Note: Buttons 11 and 12 are not used in this configuration.

Button 1 is fixed.

TP600 Panel Configuration

Button Layout Table

Button #	Setup 1	Setup 2	Setup 3
1	Jets 1	Jets 1	Jets 1
2	Jets 2	Blower	Undefined
3	Invert	Invert	Invert
4	Up	Up	Up
5	Light 1	Light 1	Light 1
6	Down	Down	Down
LED 1	Jets 1	Jets 1	Jets 1
LED 2	Jets 2	Blower	Undefined
LED 3	Light 1	Light 1	Light 1
LED 4	Heat On	Heat On	Heat On

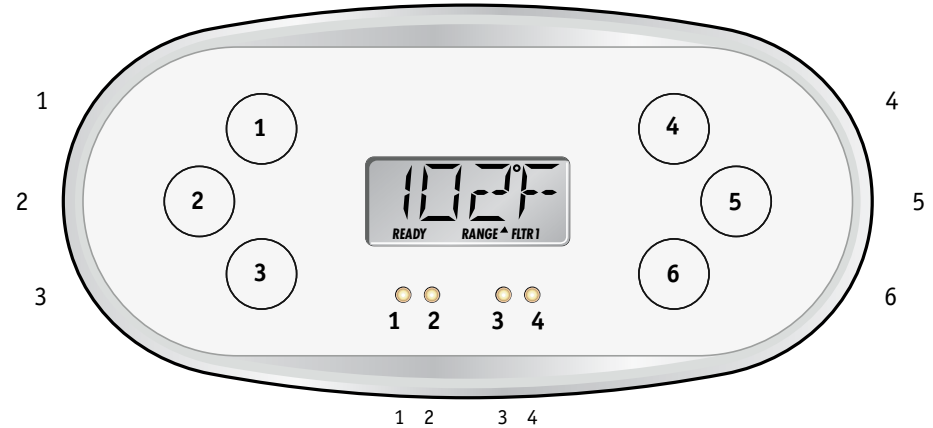

TP600

55676-XX

No Overlay

TP400 Panel Configuration

Button Layout Table for TP400T

Button #	Setup 1	Setup 2	Setup 3
1	Temperature	Temperature	Temperature
2	Jets 1	Jets 1	Jets 1
3	Light 1	Light 1	Light 1
4	Jets 2	Blower	Undefined
LED 1	Heater ON	Heater ON	Heater ON
LED 2	Jets 1 ON	Jets 1 ON	Jets 1 ON
LED 3	Light ON	Light ON	Light ON
LED 4	Jets 2 ON	Blower ON	Undefined

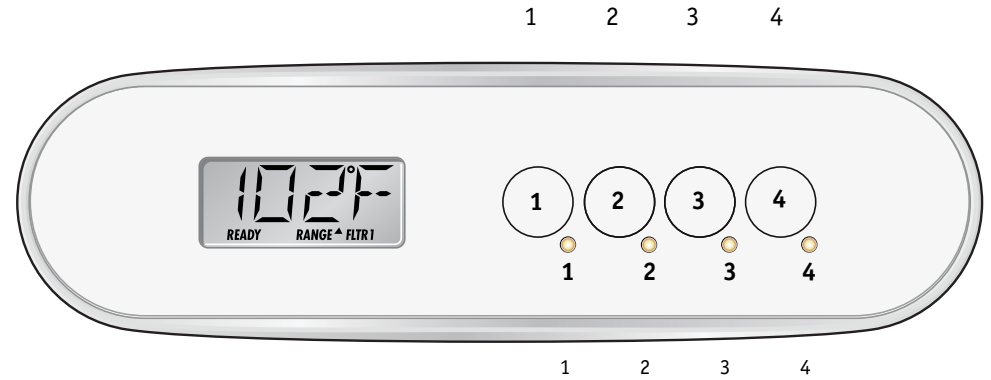

TP400T US

50380-XX

Includes overlay PN 12511.

Button Layout Table for TP400W

Button #	All Setups
1	Up
2	Down
3	Light 1
4	Jets 1
LED 1	Heater ON
LED 2	Undefined
LED 3	Light ON
LED 4	Jets 1 ON

Use the TP400W for setups that only have one pump (No Blower or Pump 2).

TP400W US

50384-XX

Includes overlay PN 12510.

BP501 Configuration Options

Auxilliary Panel Features on Bank 1*

Feature	Default
Aux Button A1	Jets 1
Aux Button A2	Jets 2 in Setup 1 Blower in Setup 2 Undefined in Setup 3
Aux Button A3	Undefined
Aux Button A4	Light

*Bank 1 consists of J5 on the Main Circuit Board.
Aux Connection Splitter PN 25257 may be required.

Buttons that are assigned to equipment that is not defined in a Setup will not do anything in that Setup.

BP501 Configuration Options

Auxilliary Panel Features

AX10 Panels on Bank 1*

A1, AX10A1	No O/L	52803	
A2, AX10A2	No O/L	52804	
A3, AX10A3	No O/L	52805	▶
A4, AX10A4	No O/L	52806	

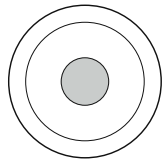

Call Customer Service for additional information about Auxiliary Panels.

*Bank 1 consists of J5 on the Main Circuit Board.
Aux Connection Splitter PN 25257 may be required.

AX20

AX20 A1A2	No O/L	52800
AX20 A1A3	No O/L	52801
AX20 A1A4	No O/L	52802

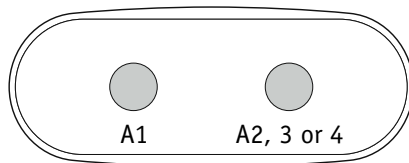

AX20 Auxiliary Panel plugged into Bank 1 will operate A1 + A2, A3 or A4.

AX40

AX40	No O/L	52799
------	--------	-------

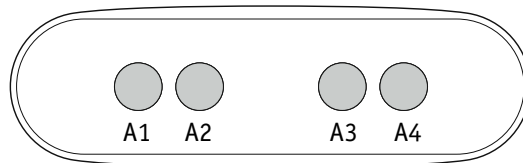

AX40 Auxiliary Panel plugged into Bank 1 will operate A1 + A2, A3 and A4.