

BP2100GO Tech Sheet

Customer: Balboa Water Group

Part Number: 56662-02 800 Incoloy 3kW
56663-02 825 Incoloy 3kW
56664-02 Titanium 3kW

Custom Box Overlay
Box Overlay Part Number N/A

CE System Model: BP21-BP2100GO-RCA3.0K
Software Version ID: M100_225 V37.0
Software Version: 37.0
File Name: BP2100_37.0_BP2100GO.hex
Configuration Signature: 358343E8

Eng. Project Number: 4890

Control Panels:

spaTouch™2	Any version (version 2.0 or later required for bba™2 fully integrated functionality)
Icon spaTouch™	Any version (version 3.36 or later required for bba™2 fully integrated functionality)
Menued spaTouch™	Any version (version 2.8 or later required for bba™2 integrated functionality)
TP900	Version 3.1 and later (Version 3.13 or later required for bba™)
TP800	Version 3.1 and later (Version 3.13 or later required for bba™; version 4.11 or later required for bba™2 integrated functionality)
TP600	Version 2.7 and later (Version 2.12 or later required for bba™/bba™2 On/Off control via menu)
TP400T CE	Version 2.7 and later (TP400T US should <u>not</u> be used) (Version 2.12 or later required for bba™/bba™2 On/Off control via menu)
TP400W CE	Version 2.7 and later (TP400W US should <u>not</u> be used) (Version 2.12 or later required for bba™/bba™2 On/Off control via menu)



Manufactured under one or more of these patents. U.S. Patents: 5332944, 5361215, 5550753, 5559720, 5,883,459, 6253227, 6282370, 6590188, 6976052, 6965815, 7030343, 7,417,834 b2, Canadian Patent: 2342614, Australian patent: 2373248 other patents both foreign and domestic applied for and pending. © Copyright 2012 Balboa Water Group.

System Revision History

Part #	EPN	Date	Originator	Changes Made
ZT000114	4381	09-18-14	BWG	New generic BP2100 with <u>no</u> Expander board.
56662 56663 56664	4381	09-25-14	BWG	Release to production.
"	N/A	12-29-14	BWG	Change model name to BP2100G0.
56662-01 56663-01 56664-01	4776	10-26-16	BWG	Updated to latest software version, adding topside-intergrated bba™2 support. Released to production.
56662-02 56663-02 56664-02	4890	05-08-17	BWG	Updated to latest software version, adding bba™/bba™2 On/Off support to TP600/TP400 Menus. Released to production.

bba™ & bba™2 (Balboa Bluetooth Amp) connection is documented seperately.

bba™ is integrated into graphic display panels (TP800, TP900 and spaTouch™). With TP600/TP400, use the "BT" entry on the menu to toggle bba™ power On/Off.

bba™2 is integrated into graphic display panels (TP800, TP900 and spaTouch™). With TP600/TP400, use the "BT" entry on the menu to toggle bba™2 power On/Off.

Basic Functions Setups 1-14

Power Requirements:

Single Service [3 wires (line, neutral, ground)] – RESTRICTED OPERATIONS (See page 5)
230VAC, 50/60Hz*, 1p, 32A, (Circuit Breaker rating = 40A max.)

Dual Service [5 wires (line 1, neutral 1, line 2, neutral 2, ground)]
230VAC, 50/60Hz, 2p, 16A, (Circuit Breaker rating = 20A max each phase line.)

3-Service [5 wires (line 1, line 2, line 3, neutral, ground)]
230VAC line-to-neutral**, 50/60Hz*, 3p, 16A, (Circuit Breaker rating = 20A max each phase line.)

* BP systems automatically detect 50Hz vs 60Hz.

** 3-phase service measured line-to-line will read about 400V, but BP systems do not use it line-to-line.

IMPORTANT - Service must include a neutral wire, with a line to neutral voltage of 230VAC.

In 3x16A Service:

Pump 2 and Blower (if any) are on one service.

The Heater is on another service.

Everything else is on the remaining service.

In 2x16A Service:

Pump 2, Blower (if any), and the Heater are on one service.

Everything else is on the other service.

HiPot Testing Note:

Disconnect slip terminal with green wires from J11 prior to performing HiPot test. Failure to disconnect may cause a false failure of the test. Reconnect terminal to J11 after successful completion of HiPot test.

Basic Functions Setups 1-14

System Outputs:

Pump 1	230VAC	2-Speed 1-Speed in Setups 6 - 9	11A max*	15-minute timer for High Speed, 15-Minute timer for Low Speed
		This is the heater pump in Setups 10 - 14 Must deliver 20 GPM through heater		
Pump 2	230VAC	2-Speed 1-Speed in Setups 2, 3, 6, 7, 11 & 12 Unused in Setups 4, 5, 8, 9, 13 & 14	11A max*	15-minute timer
Blower	230VAC	1 Speed Unused in Setups 1, 3, 5, 7, 9, 10, 12 & 14	5A max*	15-minute timer
Circ Pump	230VAC	1-Speed This is the heater pump in Setups 1 - 9 Must deliver 20 GPM through heater	2A max*	Programmable Filtration Cycles + Polling
Ozone	230VAC		.5A max*	Slaved to Circ Pump in Setups 1 - 9 Independent in Setups 10 - 14
Spa Light	10VAC	On/Off	1A max	240-minute timer.
A/V (Stereo)	230VAC	Hot	2A max*	Always on
Heater	3.0kW @ 240VAC max			

* These are individual maximums but depending on the electrical services they may need to be reduced.

Hardware Setup

Wiring Diagram



BP2100G0 - PN 56662-02
05-08-17

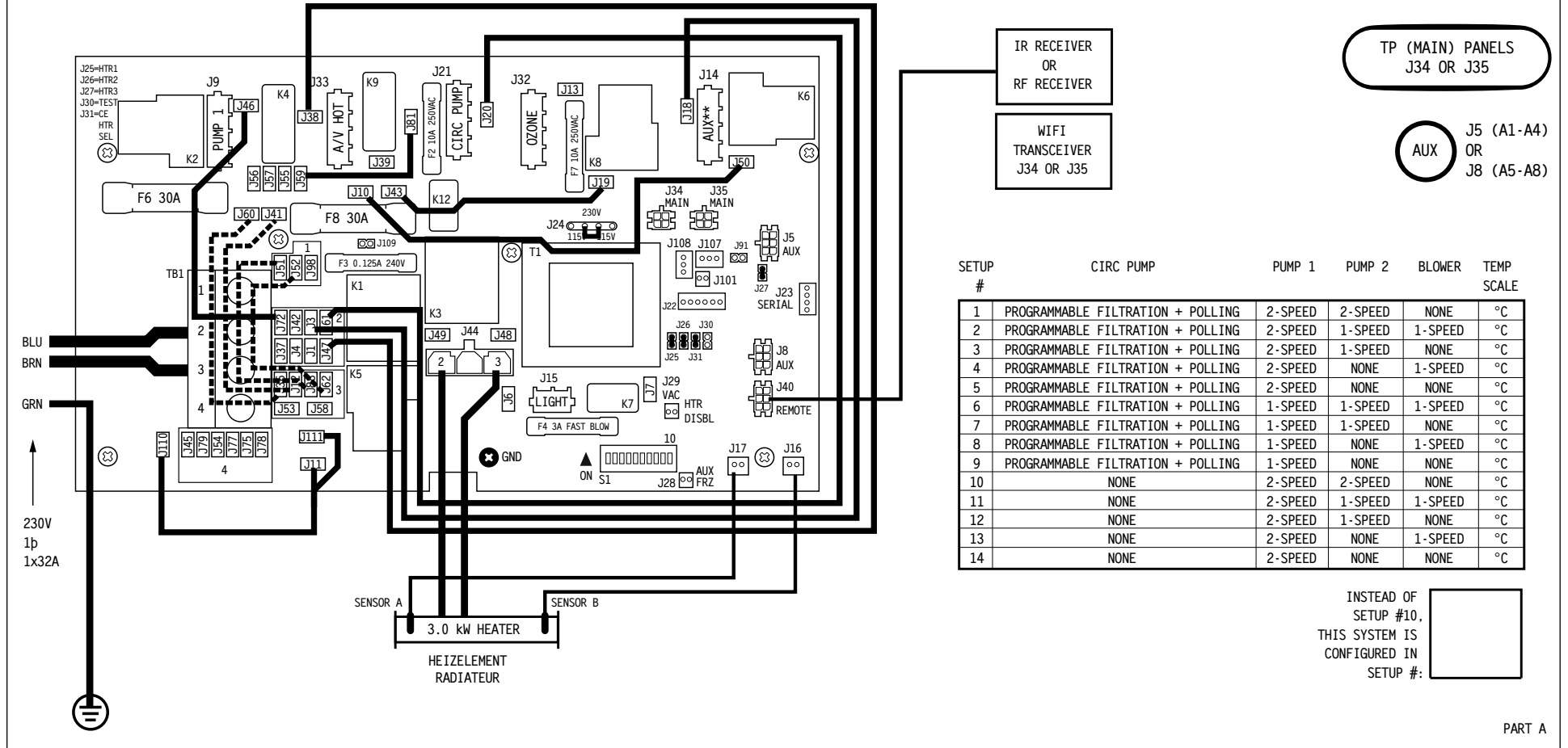

PART A

Hardware Setup

Settings

SINGLE SERVICE 230V 1p / 1x32A, THREE-SERVICE 230V 1p / 3x16A

LOCATION	DEVICE
J9	NETZSTROMVERSORGUNG 2-GESCHW.-PUMPE 1 ALIMENTATION POMPE 1 A 2 VITESSES 2-SPEED PUMP 1
J14	AUX**
	AUX LINE 1 CONNECTION J19 to J43, J50 to J10
J15	10V BELEUCHTUNG ECLAIRAGE BAIN HYDRO SPA LIGHT
J21	KREISLAUF PUMPE POMPE DE CIRCULATION CIRC PUMP (SETUPS 7-14, 16)
J32	OZONGENERATOR GENERATOROZONE OZONE GENERATOR
	CIRC AND OZONE LINE 1 CONNECTION J81 to J59
J33	TV / AV
J40	IR RECIEVER
J5, J8	AUX PANEL(S) - AX10, AX20, AX30, AX40

SWITCHBANK S1 OFF

SWITCHBANK S1 ON

TEST MODE OFF	TEST MODE ON
DON'T ADD 1 HS PUMP W/HTR	ADD 1 HS PUMP WITH HEAT
DON'T ADD 2 HS PUMPS W/HTR	ADD 2 HS PUMPS WITH HEAT
DON'T ADD 4 HS PUMPS W/HTR	ADD 4 HS PUMPS WITH HEAT
SPECIAL AMPERAGE RULE A	SPECIAL AMPERAGE RULE B
STORE SETTINGS*	MEMORY RESET*
1 MIN HTR COOLDOWN (ELEC)	5 MIN HTR COOLDOWN (GAS)
NOT ASSIGNED	NOT ASSIGNED
NOT ASSIGNED	NOT ASSIGNED
NOT ASSIGNED	NOT ASSIGNED

*SWITCH # 6 SHOULD BE SET TO OFF UPON FINAL INSTALLATION.

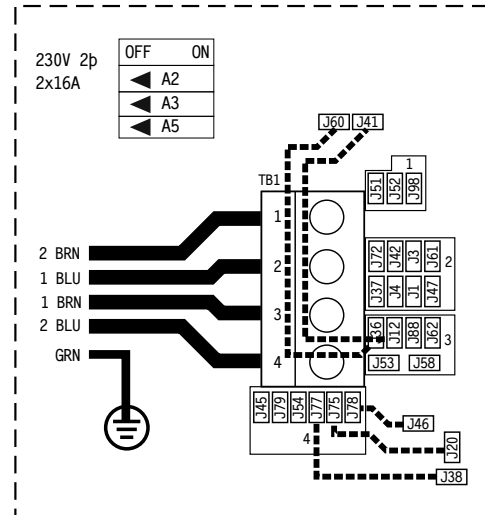
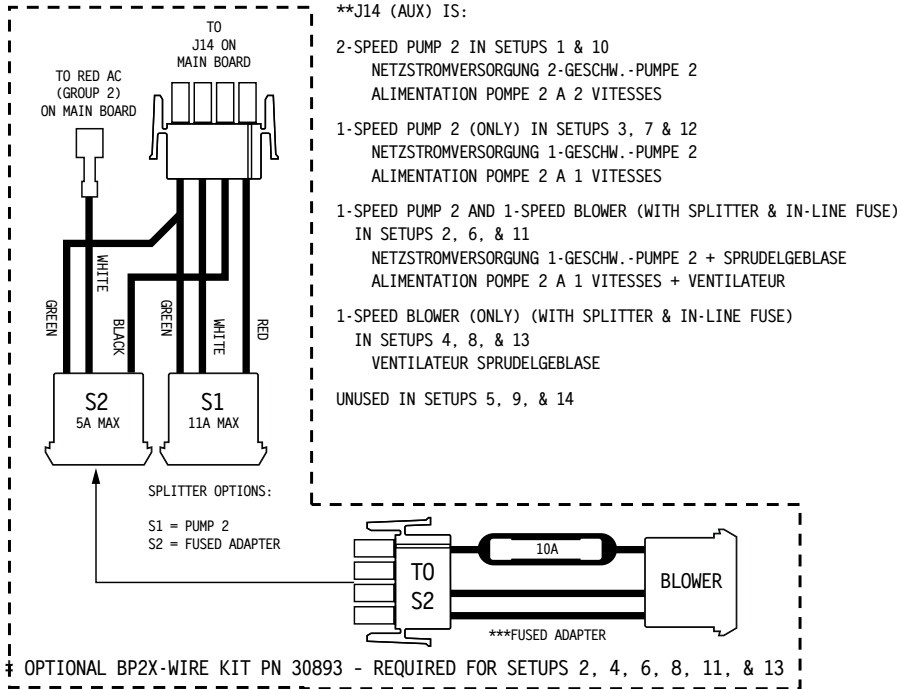

FOR SUPPLY CONNECTIONS,
USE CONDUCTORS SIZED ON THE
BASIS OF 60°C AMPACITY BUT
RATED MINIMUM OF 90°C.

USE COPPER CONDUCTORS ONLY.
EMPLOYER UNIQUEMENT
DES CONDUCTEURS DE CUIVRE.

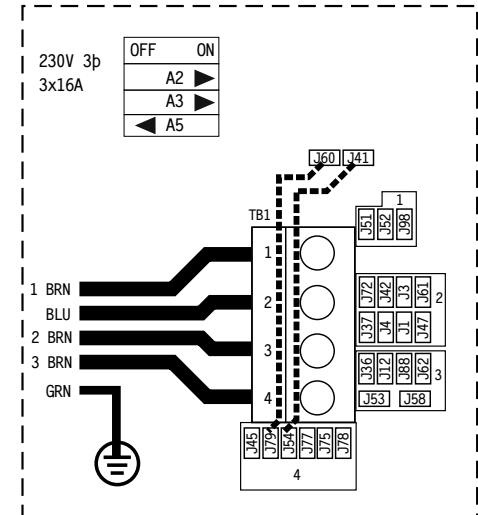

TORQUE RANGE FOR
MAIN TERMINAL BLOCK (TB1):
27-30 IN. LBS.
(31.1-34.5 kg cm)

PART B

Setup Reference Table

Setup #	Circ Pump	Pump 1	Pump 2	Blower	Temp Scale
1	Programmable Filtration + Polling	2-Speed	2-Speed	None	°C
2	Programmable Filtration + Polling	2-Speed	1-Speed	1-Speed	°C
3	Programmable Filtration + Polling	2-Speed	1-Speed	None	°C
4	Programmable Filtration + Polling	2-Speed	None	1-Speed	°C
5	Programmable Filtration + Polling	2-Speed	None	None	°C
6	Programmable Filtration + Polling	1-Speed	1-Speed	1-Speed	°C
7	Programmable Filtration + Polling	1-Speed	1-Speed	None	°C
8	Programmable Filtration + Polling	1-Speed	None	1-Speed	°C
9	Programmable Filtration + Polling	1-Speed	None	None	°C
10	None	2-Speed	2-Speed	None	°C
11	None	2-Speed	1-Speed	1-Speed	°C
12	None	2-Speed	1-Speed	None	°C
13	None	2-Speed	None	1-Speed	°C
14	None	2-Speed	None	None	°C

System (and any replacement board)
is shipped in Setup 10

Color Key	Output
	J14 (Aux) and splitter and in-line Blower fuse
	J14 (Aux) on Main Board

Changing Software Setups with spaTouch™ Icon-Driven Panels

Test Menu Access (S1, Switch 1 ON) *Service Technician ONLY.*

DANGER! HIGH VOLTAGE WILL BE ACCESSIBLE! SERVICE TECHNICIAN ONLY!

While the system is running, move DIP Switch 1 (on S1 on the Main circuit board) to ON. The system will enter Test Mode. Moving DIP Switch 1 to OFF will exit Test Mode.

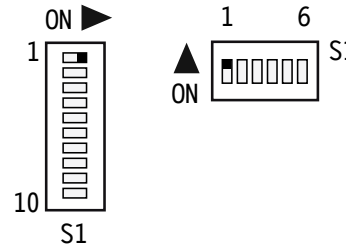

To Change Software Setups:

While in Test Mode, press the indicated icons to move from screen to screen.

The example screens shown here are from the spaTouch 1 Icon-Driven Panel, but the screens on the spaTouch 2 Panel are similar. The main difference is that the spaTouch 2 display is wider.

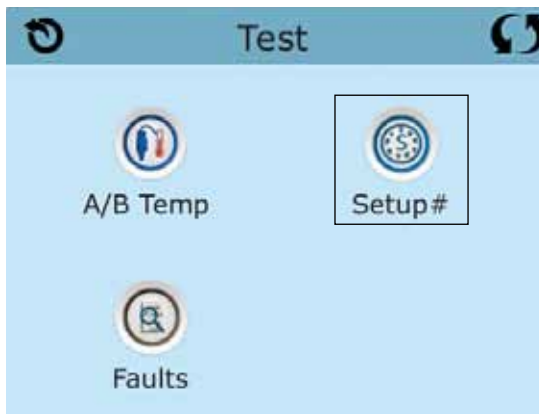
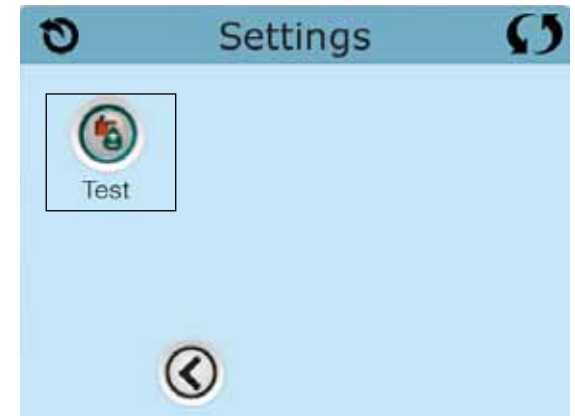

Once on the Setup Selection screen, press the Up or Down icon to select the desired Setup Number, then press the Check Mark icon to confirm and to have the spa restart.

After the system restarts, you may see a message that "The settings have been reset"; this is normal after changing Setups with DIP Switch 6 in the OFF position. Press "Clear" to dismiss this message.

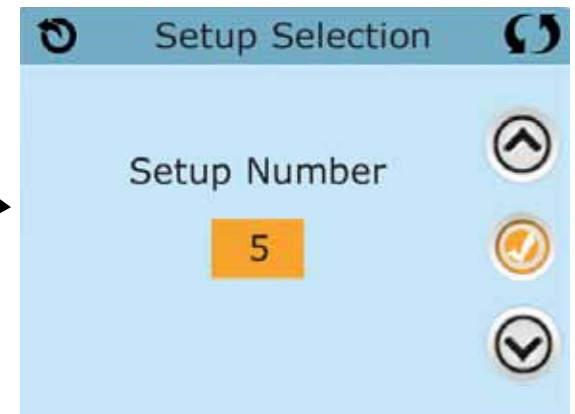

Manufactured under one or more of these patents. U.S. Patents: 5332944, 5361215, 5550753, 5559720, 5,883,459, 6253227, 6282370, 6590188, 6976052, 6965815, 7030343, 7,417,834 b2, Canadian Patent: 2342614, Australian patent: 2373248 other patents both foreign and domestic applied for and pending. © Copyright 2012 Balboa Water Group.

Changing Software Setups with TP800 / TP900 / spaTouch™ Menued Panel

Test Menu Access (S1, Switch 1 ON) *Service Technician ONLY.*

DANGER! HIGH VOLTAGE WILL BE ACCESSIBLE! SERVICE TECHNICIAN ONLY!

While the system is running, move DIP Switch 1 (on S1 on the Main circuit board) to ON. The system will enter Test Mode. Moving DIP Switch 1 to OFF will exit Test Mode.

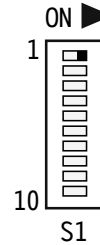

Software Setups

Under the TEST Menu, the Setup screen will allow changing the Setup from 1 to any number established by the Manufacturer. Changing the Setup may require wiring changes as well.

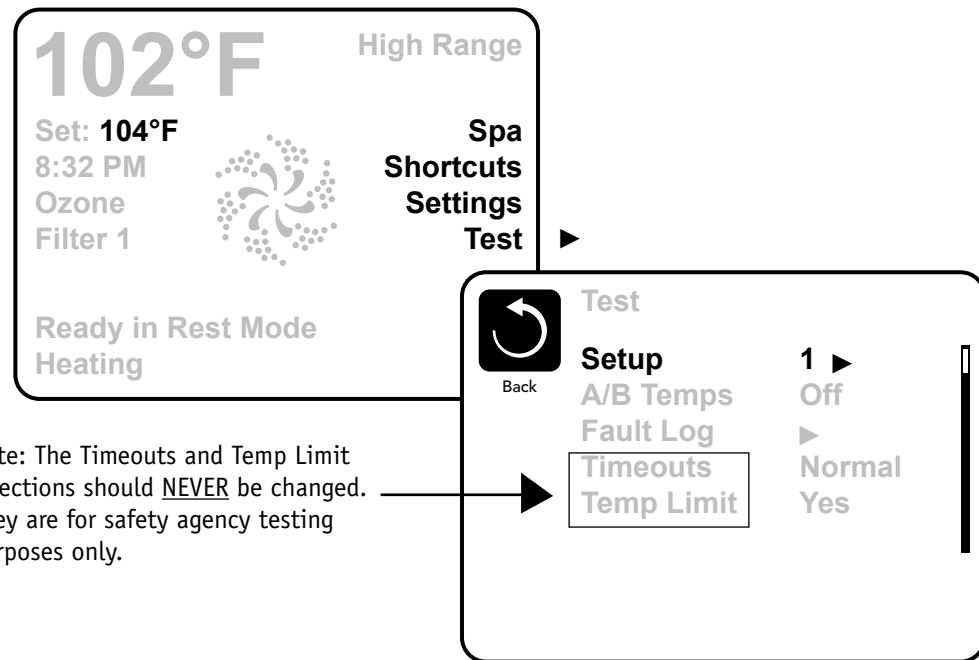

Note: The Timeouts and Temp Limit selections should NEVER be changed. They are for safety agency testing purposes only.

Equipment Expansion

Expansion Features

Control Connection

Default

Fuse

Relay 1 (J101)

Undefined

None

Relay 7/8 (J107)

Undefined

None

Relay 9/10 (J108)

Undefined

None

DIP Switch Functions

Fixed-function DIP Switches

- | | |
|----|--|
| A1 | Test Mode (normally Off). |
| A2 | In "ON" position, add one high-speed pump (or blower) with Heater. |
| A3 | In "ON" position, add two high-speed pumps (or 1 HS Pump and Blower) with Heater. |
| A4 | In "ON" position, add four high-speed pumps (or 3 HS Pumps and Blower) with Heater. |
| A5 | In "ON" position, enables Special Amperage Rule B. See Special Features section under Configuration Options for functionality with your system.
In "OFF" position, enables Special Amperage Rule A. |
| A6 | Persistent memory reset (Used when the spa is powering up to restore factory settings as determined by software configuration). |

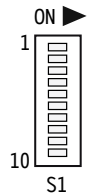

A2, A3, and A4 work in combination to determine the number of high-speed devices and blowers that can run before the heat is disabled. i.e. A2 and A3 in the ON position and A4 in the OFF position will allow the heater to operate with up to 3 high-speed pumps (or two HS Pumps and Blower) running at the same time. Heat is disabled when the fourth high-speed pump or blower is turned on.









Note: A2/A3/A4 all off = No heat with any high-speed pump or blower.

Assignable DIP Switches

- | | |
|----|---|
| A7 | In "ON" position, enables a 5-minute cooldown for some gas heaters (Cooling Time B).
In "OFF" position, enables a 1-minute cooldown for electric heaters (Cooling Time A). |
|----|---|

Undesignated switches are not assigned a function.

Jumper Definitions

J109	Non Applicable on CE models	J109 
J91	Real Time Clock Enable/Disable Note: This Jumper should NOT be shorted when the Control Panel can display time of day.	J91 
J30	Do Not Use	
J31	Jumper on 1 pin with 2.0kW or smaller heater Jumper on 2 pins with a 3.0kW or higher heater	J31 
J29	Heater Disable Switch Connection. If J29 is shorted by any means, the heater will not run until J29 is no longer shorted. If J29 is shorted during power-up “J29” will appear on the panel. The message can be dismissed with a button press, and is the only control panel notification of J29 being shorted. No message is displayed if J29 is shorted after power-up, but the heater will not run until J29 is no longer shorted. J29 expects a switch closure (not a voltage) as the command signal. In some areas, a local power company may offer discounts based on voluntary “power shedding” devices that may be installed in conjunction with the spa.	J29 
J25, J26, J27	Heater Type Settings. Note: Factory Configured do not change.	J25  J26  J27 
J24	Jumper on center two pins (230V) when heater is running at 240V. Two Jumpers installed; one on left 2 pins and one on right 2 pins (115V) when heater is running at 120V.	J24  230V 115V  115V

Warning!

Setting DIP switches or jumpers incorrectly may cause abnormal system behavior and/or damage to system components. Refer to Switchbank illustration on Wiring Configuration page for correct settings for this system. Contact Balboa if you require additional configuration pages added to this tech sheet.

Manufactured under one or more of these patents. U.S. Patents: 5332944, 5361215, 5550753, 5559720, 5,883,459, 6253227, 6282370, 6590188, 6976052, 6965815, 7030343, 7,417,834 b2, Canadian Patent: 2342614, Australian patent: 2373248 other patents both foreign and domestic applied for and pending. © Copyright 2012 Balboa Water Group.

Replacement Parts

PCBA:

Main PCBA: 56665-02
Expander PCBA: N/A

HEATER(s):

Plug + Click Heater Kit: 58300 3.0kW 800kW
58301 3.0kW 825kW
58302 3.0kW Titanium
Temp Sensor Kit: 53605

CABLES:

N/A

FUSES:

Part Number	Amperage	Location
30136	30A	F6, F8, F1 (Expander)
20600	3A	F4
26397	1/8A	F3
30122	10A	F2, F7

BP2100 Configuration Options

General Features

Feature	Default
Pump 1 in Filter Cycle (Circ Only)	No
Pump 1 Low Timer	<i>15 Minutes</i>
General Pump Timer	15 Minutes
Blower Timer	15 Minutes
Mister Timer	15 Minutes
Light Timer	240 Minutes
Circ (when enabled)	Programmable + Polling
Cleanup Cycle	<i>30 Minutes</i>
Cleanup as Preference setting	<i>Yes</i>
Ozone	With Heater Pump*
Ozone Suppression	OFF
Pump Purge	60 Seconds
Blower Purge	30 Seconds
Mister Purge	5 Seconds
Purge Type	Serial - Pumps at lowest speed

* The heater Pump can be either a Circ Pump or Pump 1 Low.

BP2100 Configuration Options

Temperature Features

Feature	Default
Temperature Display	°C

All temperatures must be specified in °F. The system converts °F to °C dynamically. If Celsius is required for default settings, choose a desired °C value that (after rounding) corresponds to a Fahrenheit value.

°C	4	5	6	7	8	9	10	11	12	13	14	15	16	17	18	19	20	21	22
°F	39	41	43	45	46	48	50	52	54	55	57	59	61	63	64	66	68	70	72
°C	23	24	25	26	27	28	29	30	31	32	33	34	35	36	37	38	39	40	
°F	73	75	77	79	81	82	84	86	88	90	91	93	95	97	99	100	102	104	

Hi-Range Min. Set Temp	80°F
Hi-Range Max. Set Temp	104°F
Hi-Range Default Temp*	100°F
Lo-Range Min. Set Temp	50°F
Lo-Range Max. Set Temp	99°F
Lo-Range Default Temp*	70°F
Freeze Threshold	44°F
Freeze Type	Rotating - Pumps at Lowest Speed
Temp Lock Type	Temp + Settings

**May be changed by end-user (if enabled)*

Manufactured under one or more of these patents. U.S. Patents: 5332944, 5361215, 5550753, 5559720, 5,883,459, 6253227, 6282370, 6590188, 6976052, 6965815, 7030343, 7,417,834 b2, Canadian Patent: 2342614, Australian patent: 2373248 other patents both foreign and domestic applied for and pending. © Copyright 2012 Balboa Water Group.

BP2100 Configuration Options

Time Features

Feature	Default
Time Format*	24 Hour
Filter 1 Start Hour*	20:00 (8:00 PM)
Filter 1 Duration*	2 Hours
Filter Cycle 2 Default*	OFF
Filter 2 Start Hour*	08:00 (8:00 AM)
Filter 2 Duration*	15 Minutes
Light Cycle	Disabled
Light Cycle Default*	OFF
Light Cycle Start Hour*	21:00 (9:00 PM)
Light Cycle Duration*	15 Minutes
Cooling Time A	1 Minute
Cooling Time B	5 Minutes

**May be changed by end-user (if enabled)*

Manufactured under one or more of these patents. U.S. Patents: 5332944, 5361215, 5550753, 5559720, 5,883,459, 6253227, 6282370, 6590188, 6976052, 6965815, 7030343, 7,417,834 b2, Canadian Patent: 2342614, Australian patent: 2373248 other patents both foreign and domestic applied for and pending. © Copyright 2012 Balboa Water Group.

BP2100 Configuration Options

Reminder Features

Feature	Default
Reminders Shown*	<i>Yes</i>
Check pH	<i>OFF</i>
Check Sanitizer	<i>OFF</i>
Clean Filter	30 Days
Test GFCI	<i>65 Days</i>
Drain Water	<i>100 Days</i>
Change Cartridge	OFF
Clean Cover	<i>OFF</i>
Treat Wood	<i>OFF</i>
Change Filter	365 Days

**May be changed by end-user (if enabled)*

Manufactured under one or more of these patents. U.S. Patents: 5332944, 5361215, 5550753, 5559720, 5,883,459, 6253227, 6282370, 6590188, 6976052, 6965815, 7030343, 7,417,834 b2, Canadian Patent: 2342614, Australian patent: 2373248 other patents both foreign and domestic applied for and pending. © Copyright 2012 Balboa Water Group.

BP2100 Configuration Options

Special Features

Feature

Default

Special Amperage Rule A

No Limitation

Special Amperage Rule B

1 High Speed Pump Maximum, and also Blower turns off with 1 High Speed Pump

Drain Mode

Disabled

Demo Mode

Disabled

GFCI Trip

Not Applicable for CE Models

Ozone Slaved to Heater Pump

Yes in circ setups
No in non-circ setups

Dual Voltage Heater

Always Input Voltage

Safety Suction

Disabled

TP900 Panel Configuration

Button Layout Table

Feature #	Setups 10 & 12	Setups 1, 3 & 7	Setup 13	Setups 4 & 8	Setup 14	Setups 5 & 9	Setup 11	Setups 2 & 6
A1	N/A	N/A	N/A	N/A	N/A	N/A	N/A	N/A
A2	Jets 1	Jets 1	Jets 1	Jets 1	Jets 1	Jets 1	Jets 1	Jets 1
A3	Jets 2	Jets 2	Blower	Blower	Light 1	Light 1	Jets 2	Jets 2
A4	Light 1	Light 1	Light 1	Light 1	Invert	Invert	Blower	Blower
A5	Invert	Invert	Invert	Invert	Undefined	(Circ Icon)	Light 1	Light 1
A6	Undefined	(Circ Icon)	Undefined	(Circ Icon)	Undefined	Undefined	Invert	Invert
A7	Undefined	Undefined	Undefined	Undefined	Undefined	Undefined	Undefined	(Circ Icon)
A8	Undefined	Undefined	Undefined	Undefined	Undefined	Undefined	Undefined	Undefined
A9	Undefined	Undefined	Undefined	Undefined	Undefined	Undefined	Undefined	Undefined
A10	Undefined	Undefined	Undefined	Undefined	Undefined	Undefined	Undefined	Undefined
A11	N/A	N/A	N/A	N/A	N/A	N/A	N/A	N/A
A12	N/A	N/A	N/A	N/A	N/A	N/A	N/A	N/A
A13	Jets 1	Jets 1	Jets 1	Jets 1	Jets 1	Jets 1	Jets 1	Jets 1
A14	Jets 2	Jets 2	Blower	Blower	Undefined	Undefined	Jets 2	Jets 2
A15	Light 1	Light 1	Light 1	Light 1	Light 1	Light 1	Blower	Blower
A16	Invert	Invert	Invert	Invert	Invert	Invert	Light 1	Light 1

A Circ Icon will appear when a Circ Pump is configured.

TP900 Panel Configuration

Button #
1
2
3
4
5
6
7
8
9
10
11
12
13
14
15
16

Spa Screen

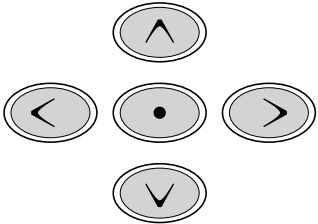
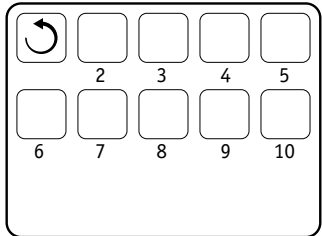

Shortcuts Screen

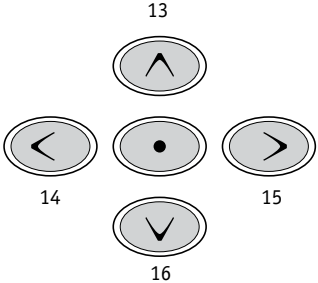
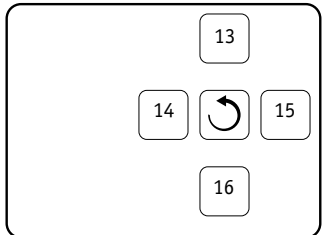

Manufactured under one or more of these patents. U.S. Patents: 5332944, 5361215, 5550753, 5559720, 5,883,459, 6253227, 6282370, 6590188, 6976052, 6965815, 7030343, 7,417,834 b2, Canadian Patent: 2342614, Australian patent: 2373248 other patents both foreign and domestic applied for and pending. © Copyright 2012 Balboa Water Group.

TP800 Panel Configuration

Button Layout Table

Feature #	Setups 10 & 12	Setups 1, 3 & 7	Setup 13	Setups 4 & 8	Setup 14	Setups 5 & 9	Setup 11	Setups 2 & 6
A1	N/A	N/A	N/A	N/A	N/A	N/A	N/A	N/A
A2	Jets 1	Jets 1	Jets 1	Jets 1	Jets 1	Jets 1	Jets 1	Jets 1
A3	Jets 2	Jets 2	Blower	Blower	Light 1	Light 1	Jets 2	Jets 2
A4	Light 1	Light 1	Light 1	Light 1	Invert	Invert	Blower	Blower
A5	Invert	Invert	Invert	Invert	Undefined	(Circ Icon)	Light 1	Light 1
A6	Undefined	(Circ Icon)	Undefined	(Circ Icon)	Undefined	Undefined	Invert	Invert
A7	Undefined	Undefined	Undefined	Undefined	Undefined	Undefined	Undefined	(Circ Icon)
A8	Undefined	Undefined	Undefined	Undefined	Undefined	Undefined	Undefined	Undefined
A9	Undefined	Undefined	Undefined	Undefined	Undefined	Undefined	Undefined	Undefined
A10	Undefined	Undefined	Undefined	Undefined	Undefined	Undefined	Undefined	Undefined
A11	N/A	N/A	N/A	N/A	N/A	N/A	N/A	N/A
A12	N/A	N/A	N/A	N/A	N/A	N/A	N/A	N/A
A13	Undefined	Undefined	Undefined	Undefined	Undefined	Undefined	Undefined	Undefined
A14	Undefined	Undefined	Undefined	Undefined	Undefined	Undefined	Undefined	Undefined
A15	Undefined	Undefined	Undefined	Undefined	Undefined	Undefined	Undefined	Undefined
A16	Undefined	Undefined	Undefined	Undefined	Undefined	Undefined	Undefined	Undefined
B1	Jets 1	Jets 1	Jets 1	Jets 1	Jets 1	Jets 1	Jets 1	Jets 1
B2	Jets 2	Jets 2	Undefined	Undefined	Undefined	Undefined	Jets 2	Jets 2
B3	Undefined	Undefined	Blower	Blower	Undefined	Undefined	Blower	Blower
B4	Light 1	Light 1	Light 1	Light 1	Light 1	Light 1	Light 1	Light 1

TP800 Panel Configuration

Spa Screen

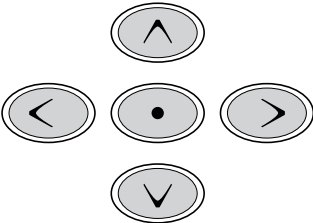
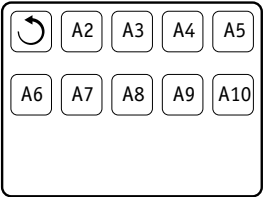
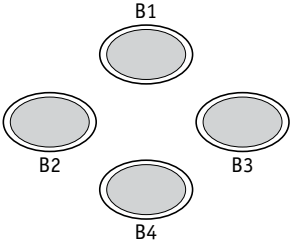

Shortcuts Screen

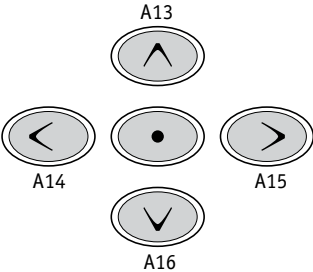
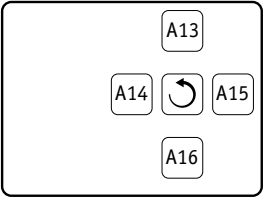
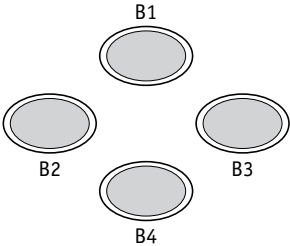

Note: Buttons 11 and 12 are not used in this configuration.
Button 1 is fixed.

A Circ Icon will appear when a Circ Pump is configured.

TP600 Panel Configuration

Button Layout Table

Button #	Setups 1, 3, 7, 10 & 12	Setups 4, 8 & 13	Setups 5, 9 & 14	Setups 2, 6 & 11
1	Jets 1	Jets 1	Jets 1	Jets 1
2	Jets 2	Blower	Undefined	Jets 2
3	Invert	Invert	Invert	Blower
4	Up	Up	Up	Up
5	Light 1	Light 1	Light 1	Light 1
6	Down	Down	Down	Down
LED 1	Jets 1	Jets 1	Jets 1	Jets 1
LED 2	Jets 2	Blower	Undefined	Jets 2
LED 3	Light 1	Light 1	Light 1	Light 1
LED 4	Heat On	Heat On	Heat On	Heat On



TP600

55676-XX

No Overlay

TP400 Panel Configuration

Button Layout Table for TP400T

Button #	Setups 1, 3, 7, 10 & 12	Setups 4, 8 & 13	Setups 5, 9 & 14
1	Temperature	Temperature	Temperature
2	Jets 1	Jets 1	Jets 1
3	Light 1	Light 1	Light 1
4	Jets 2	Blower	Undefined
LED 1	Heater ON	Heater ON	Heater ON
LED 2	Jets 1 ON	Jets 1 ON	Jets 1 ON
LED 3	Light ON	Light ON	Light ON
LED 4	Jets 2 ON	Blower ON	Undefined

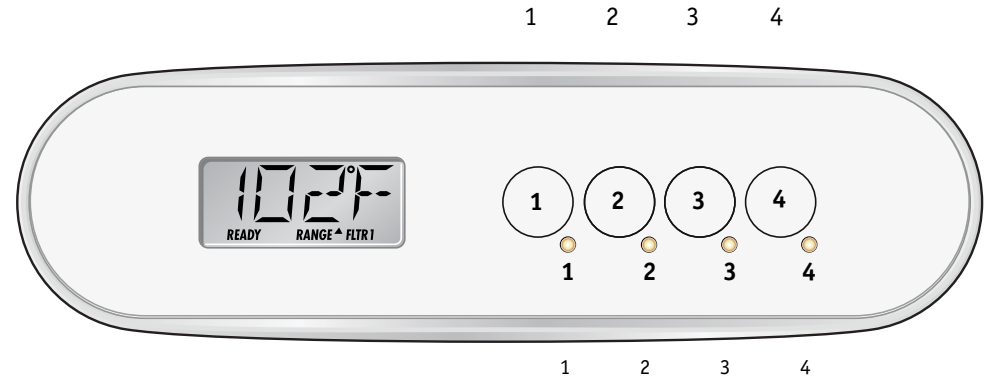

TP400T is not supported in Setups 2, 6 & 11.

TP400T CE

50260-XX

Includes overlay PN 12511.

Button Layout Table for TP400W

Button #	All Setups
1	Up
2	Down
3	Light 1
4	Jets 1
LED 1	Heater ON
LED 2	Undefined
LED 3	Light ON
LED 4	Jets 1 ON

Use the TP400W for setups that only have one pump (No Blower or Pump 2).

TP400W CE

50259-XX

Includes overlay PN 12510.

BP2100 Configuration Options

Auxilliary Panel Features on Bank 1*

Feature	Default
Aux Button A1	Jets 1
Aux Button A2	Jets 2
Aux Button A3	Blower
Aux Button A4	Light

Auxilliary Panel Features on Bank 2*

Feature	Default
Aux Button A5	Jets 1
Aux Button A6	Jets 2
Aux Button A7	Blower
Aux Button A8	Light

Buttons that are assigned to equipment that is not defined in a Setup will not do anything in that Setup.

*Bank 1 consists of J5 on the Main Circuit Board.

Bank 2 consists of J8 on the Main Circuit Board.

Aux Connection Splitter PN 25257 may be required.

BP2100 Configuration Options

Auxilliary Panel Features

AX10 Panels on Bank 1*

A1, AX10A1	No O/L	52803
A2, AX10A2	No O/L	52804
A3, AX10A3	No O/L	52805
A4, AX10A4	No O/L	52806

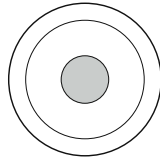

Call Customer Service for additional information about Auxiliary Panels.

AX10 Panels on Bank 2*

A5, AX10A1	No O/L	52803
A6, AX10A2	No O/L	52804
A7, AX10A3	No O/L	52805
A8, AX10A4	No O/L	52806

*Bank 1 consists of J5 on the Main Circuit Board.
Bank 2 consists of J8 on the Main Circuit Board.
Aux Connection Splitter PN 25257 may be required.

AX20

AX20 A1A2	No O/L	52800
AX20 A1A3	No O/L	52801
AX20 A1A4	No O/L	52802

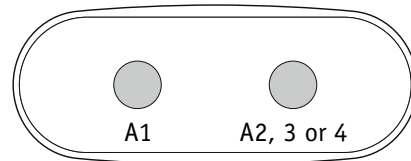

AX20 Auxiliary Panel plugged into Bank 1 will operate A1 + A2, A3 or A4.
AX20 Auxiliary Panel plugged into Bank 2 will operate A5 + A6, A7 or A8.

AX40

AX40	No O/L	52799
------	--------	-------

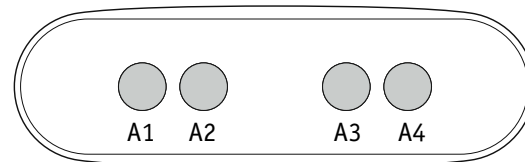

AX40 Auxiliary Panel plugged into Bank 1 will operate A1 + A2, A3 and A4.
AX40 Auxiliary Panel plugged into Bank 2 will operate A5 + A6, A7 and A8.

BP2100 Configuration Options

Remote Panel Features

Feature	Default
Remote Button A1	Jets 1
Remote Button A2	Jets 2
Remote Button A3	Undefined
Remote Button A4	Blower
Remote Button A5	Light
Remote Button A6	Undefined
Remote Button A7	Undefined
Remote Button A8	Undefined

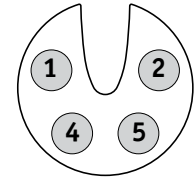

Buttons that are assigned to equipment that is not defined in a Setup will not do anything in that Setup.

Remote Panel Part Number _____
Overlay Part Number _____

Manufactured under one or more of these patents. U.S. Patents: 5332944, 5361215, 5550753, 5559720, 5,883,459, 6253227, 6282370, 6590188, 6976052, 6965815, 7030343, 7,417,834 b2, Canadian Patent: 2342614, Australian patent: 2373248 other patents both foreign and domestic applied for and pending. © Copyright 2012 Balboa Water Group.