

# BP2000G1 Tech Sheet

**Customer:** Balboa Water Group

**Part Number:** 56377-02 800 Incoloy 5.5kW  
56378-02 825 Incoloy 5.5kW  
56379-02 Titanium 5.5kW  
56589 Titanium 4kW

Custom Box Overlay   
Box Overlay Part Number N/A

UL System Model: BP20-BP2000G1-AU  
Software Version ID: M100\_220 V20.0  
Software Version: 20.0  
File Name: BP2000\_20.0\_BP2000G1\_18.hex  
Configuration Signature: 51800C6B

Eng. Project Number: 4132

Base PCBA: 56380-02

Control Panels:

TP600 version 2.7 or later (TP600CE may be used)

TP800 version 3.1 or later (Version 3.13 or later required for bba™)

TP900 version 3.1 or later (Version 3.13 or later required for bba™)



Manufactured under one or more of these patents. U.S. Patents: 5332944, 5361215, 5550753, 5559720, 5,883,459, 6253227, 6282370, 6590188, 6976052, 6965815, 7030343, 7,417,834 b2, Canadian Patent: 2342614, Australian patent: 2373248 other patents both foreign and domestic applied for and pending. © Copyright 2009 Balboa Water Group.

# System Revision History

Part #	EPN	Date	Originator	Changes Made
56377 56377 56377	3936	10-08-12	BWG	Initial Release BP2000G1
56377-01 56377-01 56377-01	4008	01-29-13	BWG	Add Setups 17 and 18, Add TP600 Support
56377-02 56377-02 56377-02	4132	09-26-13	BWG	Updated to latest software version. Adds GFCI Trip (but not GFCI Automatic Test).
56377-02 56377-02 56377-02	4132	01-30-14	BWG	Updated to latest software version, adding topside-intergrated bba™ support. Released to production.

bba™ (Balboa Bluetooth Amp) connection is documented seperately.

bba™ is only integrated into graphic display panels (TP800, TP900 and spaTouch™). With TP600 the Aux button operation of bba™ must be used.

# Basic Functions Setup 1-18

## Power Requirements:

240VAC, 50/60Hz\*, 48A, Class A GFCI-protected service (Circuit Breaker = 60A max.),  
4 wires [hot, hot, neutral, ground]

\*BP systems automatically detect 50Hz vs 60Hz.

## System Outputs:

Pump 1	240VAC	2-Speed 1-Speed in Setups 12, 14, 17	12A max	15-minute timer for High Speed, 15-Minute timer for Low Speed
		This is the heater pump in Setups 1-6, 15, 18 Must deliver 20 GPM through heater		
Pump 2	240VAC	2-Speed 1-Speed in Setups 5, 6, 11-14, 17, 18	12A max	15-minute timer
Pump 3	240VAC	2-Speed 2-Speed in Setups 1, 7 1-Speed in Setups 2, 5, 6, 8, 11-16 Unused in Setups 3, 4, 9, 10, 17, 18	12A max	15-minute timer
Blower	240VAC	1 Speed Unused in Setups 1, 2, 4, 6-8, 10, 13, 14	4A max	15-minute timer
Circ Pump	120VAC*	1-Speed This is the heater pump in Setups 7-14, 16, 17 Must deliver 20 GPM through heater	2A max	Programmable Filtration Cycles + Polling
Ozone	120VAC*		.5A max	Slaved to Circ Pump in Setups 7-14, 16, 17 Independent in Setups 1-6, 15, 18
Spa Light	10VAC	On/Off	1A max	240-minute timer.
A/V (Stereo)	120VAC	Hot	5A max	Always on
Heater	5.5kW @ 240VAC max			

\*Both the Circ pump and Ozone can be converted to 240V, however they will be the same voltage after conversion. (Both 120V or both 240V.)

# Hardware Setup

## Wiring Diagram

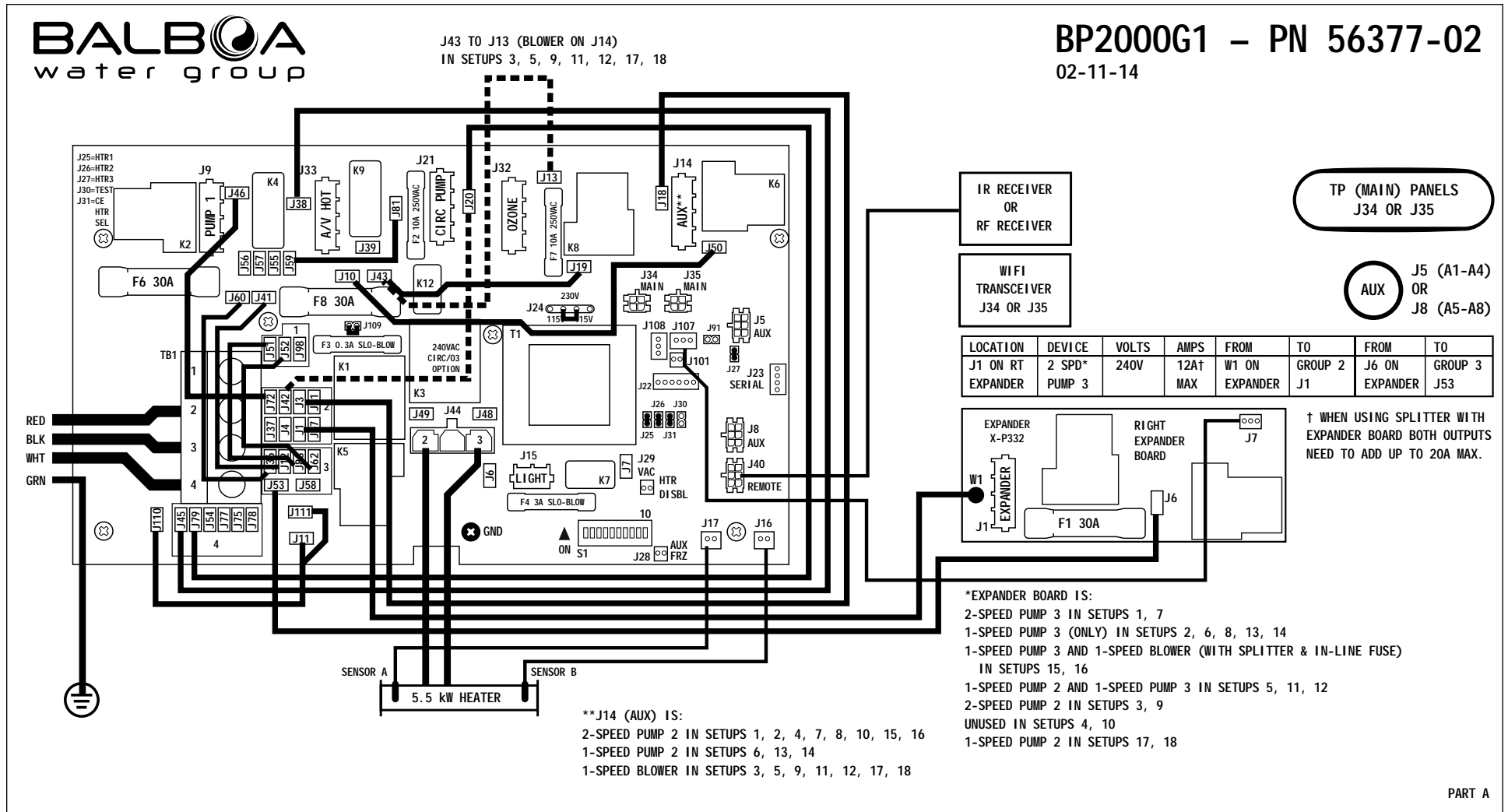

# Hardware Setup

## Settings

LOCATION	DEVICE	VOLTS	MAX AMPS	FROM	TO
J9	PUMP 1	240V	12A MAX	J46	J72-GROUP 2
J14	AUX	240V	12A MAX	J18	J3-GROUP 2
AUX LINE 1 CONNECTION				J19	J43
J15	SPA LIGHT	12V	1A		
J21	CIRC PUMP	120V*	2A MAX	J20	J79-GROUP 4
J32	OZONE		1A		
CIRC AND OZONE LINE 1 CONNECTION				J81	J59
J33	TV / AV	120V	3A	J38	J45-GROUP 4
J44	HEATER	240V	5.5 kW		

\* FOR 240V CIRC PUMP AND OZONE, CONNECT J20 TO J42 (IN GROUP 2)

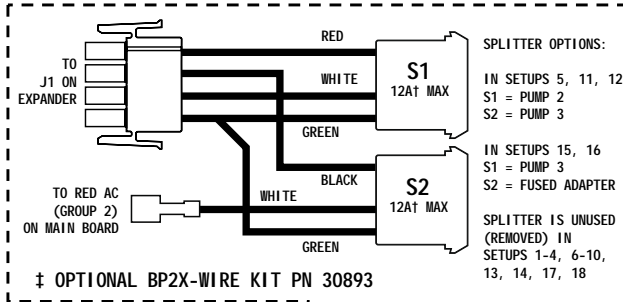

SWITCHBANK S1 OFF

SWITCHBANK S1 ON

TEST MODE OFF	◀ A1	▶ A2	TEST MODE ON
DON'T ADD 1 HS PUMP W/HTR	◀ A3	▶ A4	ADD 1 HS PUMP WITH HEAT
DON'T ADD 2 HS PUMPS W/HTR	◀ A5	▶ A6	ADD 2 HS PUMPS WITH HEAT
DON'T ADD 4 HS PUMPS W/HTR	◀ A7	▶ A8	ADD 4 HS PUMPS WITH HEAT
SPECIAL AMPERAGE RULE A	◀ A9	▶ A10	SPECIAL AMPERAGE RULE A
STORE SETTINGS**			MEMORY RESET**
1 MIN HTR COOLDOWN (ELEC)			5 MIN HTR COOLDOWN (GAS)
NOT ASSIGNED			NOT ASSIGNED
NOT ASSIGNED			NOT ASSIGNED
NOT ASSIGNED			NOT ASSIGNED

\*\* SWITCH # 6 SHOULD BE SET TO OFF UPON FINAL INSTALLATION.

SETUP #	CIRC PUMP	PUMP 1	PUMP 2	PUMP 3	BLOWER	TEMP SCALE
1	NONE	2-SPEED	2-SPEED	2-SPEED	NONE	°F
2	NONE	2-SPEED	2-SPEED	1-SPEED	NONE	°F
3	NONE	2-SPEED	2-SPEED	NONE	1-SPEED	°F
4	NONE	2-SPEED	2-SPEED	NONE	NONE	°F
5‡	NONE	2-SPEED	1-SPEED	1-SPEED	1-SPEED	°F
6	NONE	2-SPEED	1-SPEED	1-SPEED	NONE	°F
7	PROGRAMMABLE FILTRATION + POLLING	2-SPEED	2-SPEED	2-SPEED	NONE	°F
8	PROGRAMMABLE FILTRATION + POLLING	2-SPEED	2-SPEED	1-SPEED	NONE	°F
9	PROGRAMMABLE FILTRATION + POLLING	2-SPEED	2-SPEED	NONE	1-SPEED	°F
10	PROGRAMMABLE FILTRATION + POLLING	2-SPEED	2-SPEED	NONE	NONE	°F
11‡	PROGRAMMABLE FILTRATION + POLLING	2-SPEED	1-SPEED	1-SPEED	1-SPEED	°F
12‡	PROGRAMMABLE FILTRATION + POLLING	1-SPEED	1-SPEED	1-SPEED	1-SPEED	°F
13	PROGRAMMABLE FILTRATION + POLLING	2-SPEED	1-SPEED	1-SPEED	NONE	°F
14	PROGRAMMABLE FILTRATION + POLLING	1-SPEED	1-SPEED	1-SPEED	NONE	°F
15‡	NONE	2-SPEED	2-SPEED	1-SPEED	1-SPEED	°F
16‡	PROGRAMMABLE FILTRATION + POLLING	2-SPEED	2-SPEED	1-SPEED	1-SPEED	°F
17	PROGRAMMABLE FILTRATION + POLLING	1-SPEED	1-SPEED	NONE	1-SPEED	°F
18	NONE	2-SPEED	1-SPEED	NONE	1-SPEED	°F

PUMP 1 LOW TIMEOUT IS 15 MINUTES.

‡SETUPS 5, 11, 12, 15 AND 16 REQUIRE BP2X-WIRE KIT PN30893

INSTEAD OF  
SETUP #1,  
THIS SYSTEM IS  
CONFIGURED IN  
SETUP #:



**BALBOA**  
water group

**BP2000G1 - PN 56377-02**

02-11-14

PART B

USE COPPER CONDUCTORS ONLY.  
EMPLOYER UNIQUEMENT DES CONDUCTEURS DE CUIVRE.  
#6 AWG MIN. WIRE = 90°

FOR SUPPLY CONNECTIONS, USE CONDUCTORS SIZED ON THE BASIS OF  
60°C AMPACITY BUT RATED MINIMUM OF 90°C.

TORQUE RANGE FOR MAIN TERMINAL BLOCK (TB1):  
27-30 IN. LBS. (31.1-34.5 kg cm)

CONNECT ONLY TO CIRCUITS PROTECTED BY A CLASS A GFCI.

A DISCONNECTING MEANS MUST BE INSTALLED WITHIN SIGHT FROM  
THE EQUIPMENT AND AT LEAST 5 FEET (1.52 M) FROM THE  
INSIDE WALLS OF THE POOL, SPA, OR HOT TUB.

TOTAL OUTPUT AMP DRAW NOT TO EXCEED MAX INPUT RATING OF SPA  
USE EARTH GROUND CONNECTIONS AS INDICATED INSIDE THE SYSTEM ENCLOSURE

# Setup Reference Table

Setup #	Circ Pump	Pump 1	Pump 2	Pump 3	Blower	Temp Scale
1	None	2-Speed	2-Speed	2-Speed	None	°F
2	None	2-Speed	2-Speed	1-Speed	None	°F
3	None	2-Speed	2-Speed	None	1-Speed	°F
4	None	2-Speed	2-Speed	None	None	°F
5	None	2-Speed	1-Speed	1-Speed	1-Speed	°F
6	None	2-Speed	1-Speed	1-Speed	None	°F
7	Programmable Filtration + Polling	2-Speed	2-Speed	2-Speed	None	°F
8	Programmable Filtration + Polling	2-Speed	2-Speed	1-Speed	None	°F
9	Programmable Filtration + Polling	2-Speed	2-Speed	None	1-Speed	°F
10	Programmable Filtration + Polling	2-Speed	2-Speed	None	None	°F
11	Programmable Filtration + Polling	2-Speed	1-Speed	1-Speed	1-Speed	°F
12	Programmable Filtration + Polling	1-Speed	1-Speed	1-Speed	1-Speed	°F
13	Programmable Filtration + Polling	2-Speed	1-Speed	1-Speed	None	°F
14	Programmable Filtration + Polling	1-Speed	1-Speed	1-Speed	None	°F
15	None	2-Speed	2-Speed	1-Speed	1-Speed	°F
16	Programmable Filtration + Polling	2-Speed	2-Speed	1-Speed	1-Speed	°F
17	Programmable Filtration + Polling	1-Speed	1-Speed	None	1-Speed	°F
18	None	2-Speed	1-Speed	None	1-Speed	°F

**System** (and any replacement board) **is shipped in Setup 1**

Color Key	Output
	XP332
	XP332 and Splitter
	XP332 and Splitter and in-line Blower fuse
	J14 (Aux) on Main Board

# Changing Software Setups with TP800 / TP900 / spaTouch™ Menued Panel

## Test Menu Access (S1, Switch 1 ON) *Service Technician ONLY.*

**DANGER! HIGH VOLTAGE WILL BE ACCESSIBLE! SERVICE TECHNICIAN ONLY!**

While the system is running, move DIP Switch 1 (on S1 on the Main circuit board) to ON.  
The system will enter Test Mode.  
Moving DIP Switch 1 to OFF will exit Test Mode.

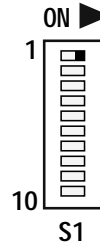

## Software Setups

Under the TEST Menu, the Setup screen will allow changing the Setup from 1 to any number established by the Manufacturer.  
Changing the Setup may require wiring changes as well.

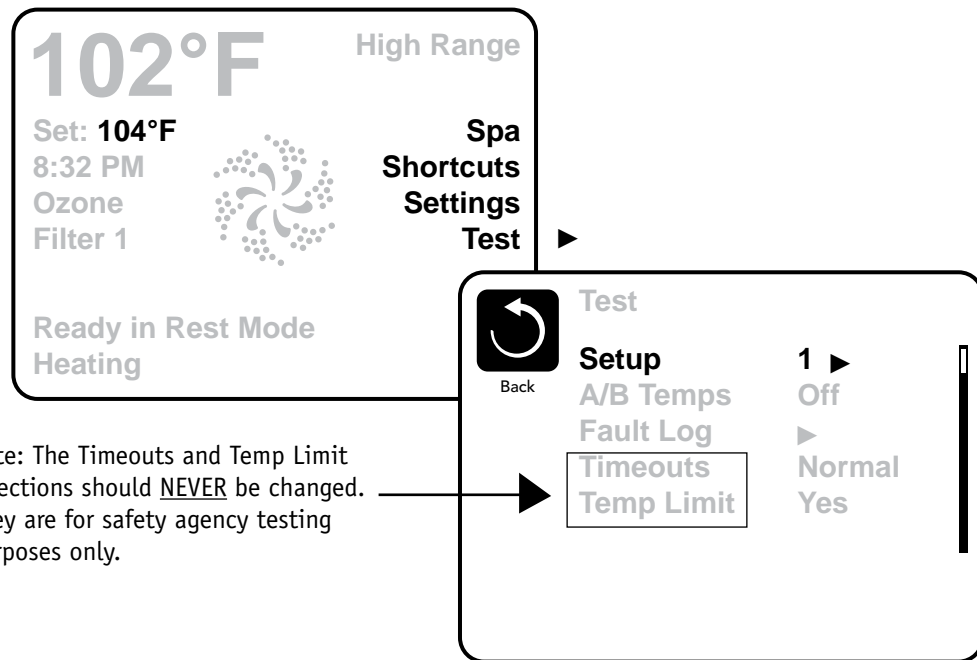

# Changing Software Setups with TP600/400

## Test Menu Access (S1, Switch 1 ON) *Service Technician ONLY.*

**DANGER! HIGH VOLTAGE WILL BE ACCESSIBLE! SERVICE TECHNICIAN ONLY!**

While the system is running, move DIP Switch 1 (on S1 on the Main circuit board) to ON. The system will enter Test Mode. Moving DIP Switch 1 to OFF will exit Test Mode.

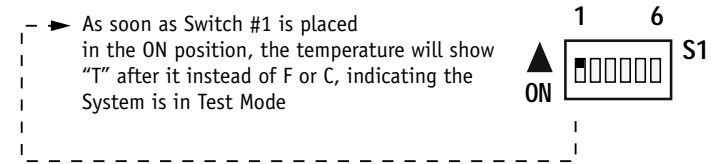

## Software Setups

Under the TEST Menu, the Setup screen will allow changing the Setup from 1 to any number established by the Manufacturer. Changing the Setup may require wiring changes as well.

**You will have 1 minute** to complete the setup change after you manually exit Priming Mode. (Once familiar with the process, the Setup change should take less than 15 seconds.)



When the panel displays RUN PMPS PURG AIR, press any Temperature button ONCE to exit Priming Mode. You should see “---T” where the T indicates the system is in Test Mode.

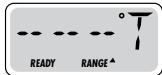

Continued on Next Page.



# Changing Software Setups with TP600/400 Continued

Again, **You will have 1 minute** to complete the setup change after you manually exit Priming Mode.

Immediately after exiting Priming Mode, press this sequence of buttons: Warm\*, Light, Warm, Warm, Warm, Warm. Continue to press Warm until the display shows the Setup Number (S-01, S-02, etc.) you want to switch to. When the correct setup number is showing, press Light once, and the system will reset, using the newly-selected Setup from that point on.

Move DIP Switch 1 to the OFF position to take the spa out of Test Mode. °F or °C will replace °T.

**Using a permanent marker, write the Setup number on the Setup label mounted inside the system lid (right). This is very important to any service person in the future who may need to replace a circuit board or system and needs to change the Setup on a replacement part while in the field.**

NOTE: Changing the Setup may require wiring changes as well - refer to the wiring diagram or wiring diagram addendum.

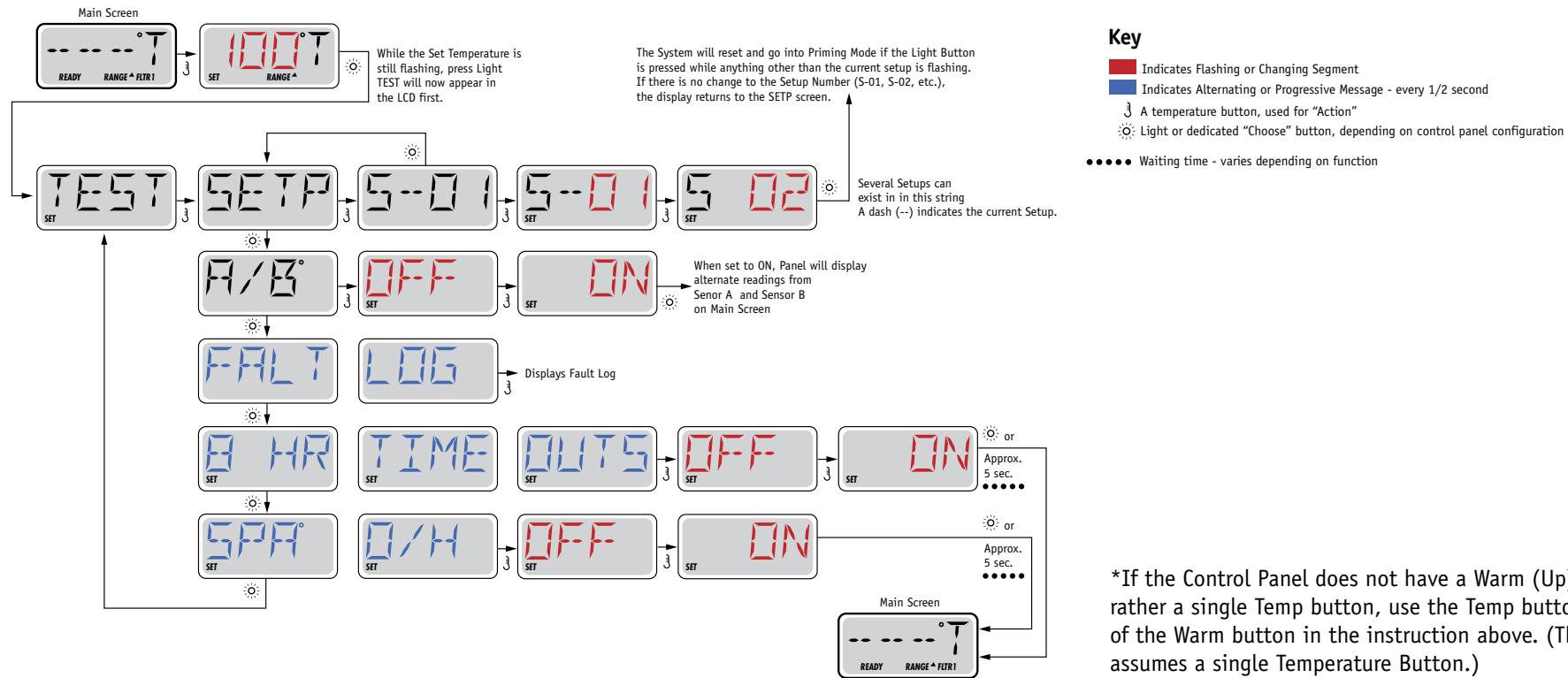
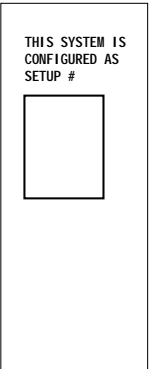

Manufactured under one or more of these patents. U.S. Patents: 5332944, 5361215, 5550753, 5559720, 5,883,459, 6253227, 6282370, 6590188, 6976052, 6965815, 7030343, 7,417,834 b2, Canadian Patent: 2342614, Australian patent: 2373248 other patents both foreign and domestic applied for and pending. © Copyright 2009 Balboa Water Group.



# Equipment Expansion

---

## Expansion Features

### Control Connection

	<b>Default</b>	<b>Fuse</b>
Relay 1 (J101)	Undefined	None
Relay 7/8 (J107)	See Below	30A
	2-Speed Pump 3 in Setups 1, 7	
	1-Speed Pump 3 (only) in Setups 2, 6, 8, 13, 14	
	1-Speed Pump 3 And 1-Speed Blower (With Splitter & In-Line Fuse) in Setups 15, 16	
	1-Speed Pump 2 And 1-Speed Pump 3 in Setups 5, 11, 12	
	2-Speed Pump 2 in Setups 3, 9	
	1-Speed Pump 2 in Setups 17, 18	
	Unused in Setups 4, 10	
Relay 9/10 (J108)	Undefined	None

# DIP Switch Functions

## Fixed-function DIP Switches

- A1 Test Mode (normally Off).
- A2 In "ON" position, add one high-speed pump (or blower) with Heater.
- A3 In "ON" position, add two high-speed pumps (or 1 HS Pump and Blower) with Heater.
- A4 In "ON" position, add four high-speed pumps (or 3 HS Pumps and Blower) with Heater.
- A5 In "ON" position, enables Special Amperage Rule B. See Special Features section under Configuration Options for functionality with your system.  
In "OFF" position, enables Special Amperage Rule A.
- A6 Persistent memory reset (Used when the spa is powering up to restore factory settings as determined by software configuration).

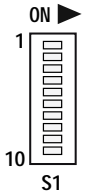

**A2, A3, and A4** work in combination to determine the number of high-speed devices and blowers that can run before the heat is disabled. i.e. A2 and A3 in the ON position and A4 in the OFF position will allow the heater to operate with up to 3 high-speed pumps (or two HS Pumps and Blower) running at the same time. Heat is disabled when the fourth high-speed pump or blower is turned on.





**Note:** A2/A3/A4 all off = No heat with any high-speed pump or blower.

## Assignable DIP Switches

- A7 In "ON" position, enables a 5-minute cooldown for some gas heaters (Cooling Time B).  
In "OFF" position, enables a 1-minute cooldown for electric heaters (Cooling Time A).

*Undesignated switches are not assigned a function.*

# Jumper Definitions

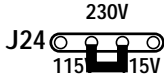
<b>J109</b>	<p>GFCI Test/Trip Enable/Disable</p> <p><b>Note:</b> This feature must be enabled in software as well.</p>	J109 
<b>J91</b>	<p>Real Time Clock Enable/Disable</p> <p><b>Note:</b> This Jumper should NOT be shorted when the Control Panel can display time of day.</p>	J91 
<b>J30</b>	<p>Do Not Use</p>	
<b>J31</b>	<p>Non Applicable on UL models (Used on CE models only)</p>	J31 
<b>J29</b>	<p>Heater Disable Switch Connection. If J29 is shorted by any means, the heater will not run until J29 is no longer shorted. If J29 is shorted during power-up “J29” will appear on the panel. The message can be dismissed with a button press, and is the only control panel notification of J29 being shorted. No message is displayed if J29 is shorted after power-up, but the heater will not run until J29 is no longer shorted. J29 expects a switch closure (not a voltage) as the command signal. In some areas, a local power company may offer discounts based on voluntary “power shedding” devices that may be installed in conjunction with the spa.</p>	J29 
<b>J25, J26, J27</b>	<p>Heater Type Settings.</p> <p><b>Note:</b> Factory Configured do not change.</p>	
<b>J24</b>	<p>Jumper on center two pins (230V) when heater is running at 240V. Two Jumpers installed; one on left 2 pins and one on right 2 pins (115V) when heater is running at 120V.</p>	

## Warning!

Setting DIP switches or jumpers incorrectly may cause abnormal system behavior and/or damage to system components. Refer to Switchbank illustration on Wiring Configuration page for correct settings for this system. Contact Balboa if you require additional configuration pages added to this tech sheet.

# BP2000 Configuration Options

---

## General Features

Feature	Default
Pump 1 in Filter Cycle (Circ Only)	No
Pump 1 Low Timer	<i>15 Minutes</i>
General Pump Timer	15 Minutes
Blower Timer	15 Minutes
Mister Timer	15 Minutes
Light Timer	240 Minutes
Circ (when enabled)	Programmable + Polling
Cleanup Cycle	<i>30 Minutes</i>
Cleanup as Preference setting	<i>Yes</i>
Ozone	With Heater Pump*
Ozone Suppression	OFF
Pump Purge	60 Seconds
Blower Purge	30 Seconds
Mister Purge	5 Seconds
Purge Type	Serial - Pumps at lowest speed

\* The heater Pump can be either a Circ Pump or Pump 1 Low.

*Blue Indicates New Custom Configuration Default (Setup 1)*

Manufactured under one or more of these patents. U.S. Patents: 5332944, 5361215, 5550753, 5559720, 5,883,459, 6253227, 6282370, 6590188, 6976052, 6965815, 7030343, 7,417,834 b2, Canadian Patent: 2342614, Australian patent: 2373248 other patents both foreign and domestic applied for and pending. © Copyright 2009 Balboa Water Group.

# BP2000 Configuration Options

## Temperature Features

Feature	Default
Temperature Display	°F

All temperatures must be specified in °F. The system converts °F to °C dynamically. If Celsius is required for default settings, choose a desired °C value that (after rounding) corresponds to a Fahrenheit value.

°C	4	5	6	7	8	9	10	11	12	13	14	15	16	17	18	19	20	21	22
°F	39	41	43	45	46	48	50	52	54	55	57	59	61	63	64	66	68	70	72
°C	23	24	25	26	27	28	29	30	31	32	33	34	35	36	37	38	39	40	
°F	73	75	77	79	81	82	84	86	88	90	91	93	95	97	99	100	102	104	

Hi-Range Min. Set Temp	80°F
Hi-Range Max. Set Temp	104°F
Hi-Range Default Temp*	100°F
Lo-Range Min. Set Temp	50°F
Lo-Range Max. Set Temp	99°F
Lo-Range Default Temp*	70°F
Freeze Threshold	44°F
Freeze Type	Rotating - Pumps at Lowest Speed
Temp Lock Type	Temp + Settings

\*May be changed by end-user (if enabled)

Blue Indicates New Custom Configuration Default (Setup 1)

Manufactured under one or more of these patents. U.S. Patents: 5332944, 5361215, 5550753, 5559720, 5,883,459, 6253227, 6282370, 6590188, 6976052, 6965815, 7030343, 7,417,834 b2, Canadian Patent: 2342614, Australian patent: 2373248 other patents both foreign and domestic applied for and pending. © Copyright 2009 Balboa Water Group.

# BP2000 Configuration Options

---

## Time Features

Feature	Default
Time Format*	12 Hour
Filter 1 Start Hour*	20:00 (8:00 PM)
Filter 1 Duration*	2 Hours
Filter Cycle 2 Default*	OFF
Filter 2 Start Hour*	08:00 (8:00 AM)
Filter 2 Duration*	15 Minutes
Light Cycle	Disabled
Light Cycle Default*	OFF
Light Cycle Start Hour*	21:00 (9:00 PM)
Light Cycle Duration*	15 Minutes
Cooling Time A	1 Minute
Cooling Time B	5 Minutes

*\*May be changed by end-user (if enabled)*

*Blue Indicates New Custom Configuration Default (Setup 1)*

Manufactured under one or more of these patents. U.S. Patents: 5332944, 5361215, 5550753, 5559720, 5,883,459, 6253227, 6282370, 6590188, 6976052, 6965815, 7030343, 7,417,834 b2, Canadian Patent: 2342614, Australian patent: 2373248 other patents both foreign and domestic applied for and pending. © Copyright 2009 Balboa Water Group.

# BP2000 Configuration Options

---

## Reminder Features

Feature	Default
Reminders Shown*	<i>Yes</i>
Check pH	<i>OFF</i>
Check Sanitizer	<i>OFF</i>
Clean Filter	30 Days
Test GFCI	<i>65 Days</i>
Drain Water	<i>100 Days</i>
Change Cartridge	OFF
Clean Cover	<i>OFF</i>
Treat Wood	<i>OFF</i>
Change Filter	365 Days

*\*May be changed by end-user (if enabled)*

*Blue Indicates New Custom Configuration Default (Setup 1)*

Manufactured under one or more of these patents. U.S. Patents: 5332944, 5361215, 5550753, 5559720, 5,883,459, 6253227, 6282370, 6590188, 6976052, 6965815, 7030343, 7,417,834 b2, Canadian Patent: 2342614, Australian patent: 2373248 other patents both foreign and domestic applied for and pending. © Copyright 2009 Balboa Water Group.



# BP2000 Configuration Options

---

## Special Features

### Feature

### Default

Special Amperage Rule A

No Limitation

Special Amperage Rule B

No Limitation

Drain Mode

Disabled

Demo Mode

Disabled

GFCI Trip

Enabled

Automatic GFCI Test

Disabled

Ozone Slaved to Heater Pump

*Yes in circ setups*  
*No in non-circ setups*

Dual Voltage Heater

Always Input Voltage

Safety Suction

Disabled

# TP600 Panel Configuration

## Button Layout Table

Button #	Pump 3 or Pump 3 + Blower*	No Pump 3, Blower	No Pump 3, No Blower
	Setups 1, 2, 5, 6, 7, 8, 11, 12, 13, 14, 15, 16	Setup 3, 9, 17, 18	Setup 4, 10
1	Jets 1	Jets 1	Jets 1
2	Jets 2	Jets 2	Jets 2
3	Jets 3	Blower	Unused
4	Up	Up	Up
5	Light 1	Light 1	Light 1
6	Down	Down	Down
LED 1	Jets 1	Jets 1	Jets 1
LED 2	Jets 2	Jets 2	Jets 2
LED 3	Light 1	Light 1	Light 1
LED 4	Heat On	Heat On	Heat On

\* When using setups in column 1, which operate both a Pump 3 AND a Blower, Pump 3 is on the main panel (Button 3) and Blower must be operated with an Auxilliary Panel - AX10A3 on Bank 1 (J5).

See Page 21.

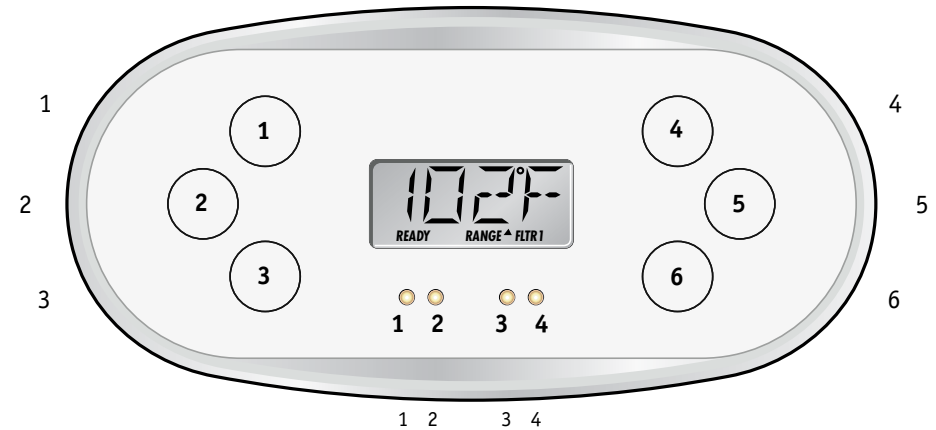

## TP600

55676-07 or later - No Overlay

50335-01 or later - Includes Overlay PN 12762



# TP800 Panel Configuration

**Button Layout Table**

Feature #	Pump 3, Blower & Circ Setups 11, 12, 16	NO Pump 3, Blower & Circ Setup 9, 17	Pump 3, NO Blower & Circ Setups 7, 8, 13, 14	NO Pump 3, NO Blower & Circ Setup 10	Pump 3, Blower & NO Circ Setups 5, 15	NO Pump 3, Blower & NO Circ Setup 3, 18	Pump 3, NO Bl & NO Circ Setups 1, 2, 6	NO Pump 3, NO Bl & NO Circ Setup 4
A1	N/A	N/A	N/A	N/A	N/A	N/A	N/A	N/A
A2	Jets 1	Jets 1	Jets 1	Jets 1	Jets 1	Jets 1	Jets 1	Jets 1
A3	Jets 2	Jets 2	Jets 2	Jets 2	Jets 2	Jets 2	Jets 2	Jets 2
A4	Jets 3	Blower	Jets 3	Light 1	Jets 3	Blower	Jets 3	Light 1
A5	Blower	Light 1	Light 1	Invert	Blower	Light 1	Light 1	Invert
A6	Light 1	Invert	Invert	(Circ Icon)	Light 1	Invert	Invert	Undefined
A7	Invert	(Circ Icon)	(Circ Icon)	Undefined	Invert	Undefined	Undefined	Undefined
A8	(Circ Icon)	Undefined	Undefined	Undefined	Undefined	Undefined	Undefined	Undefined
A9	Undefined	Undefined	Undefined	Undefined	Undefined	Undefined	Undefined	Undefined
A10	Undefined	Undefined	Undefined	Undefined	Undefined	Undefined	Undefined	Undefined
A11	N/A	N/A	N/A	N/A	N/A	N/A	N/A	N/A
A12	N/A	N/A	N/A	N/A	N/A	N/A	N/A	N/A
A13	Jets 1	Jets 1	Jets 1	Jets 1	Jets 1	Jets 1	Jets 1	Jets 1
A14	Jets 2	Jets 2	Jets 2	Jets 2	Jets 2	Jets 2	Jets 2	Jets 2
A15	Blower	Blower	Jets 3	Light	Blower	Blower	Jets 3	Light
A16	Light	Light	Light	Invert	Light	Light	Light	Invert
B1	Jets 1	Jets 1	Jets 1	Jets 1	Jets 1	Jets 1	Jets 1	Jets 1
B2	Jets 2	Jets 2	Jets 2	Jets 2	Jets 2	Jets 2	Jets 2	Jets 2
B3	Jets 3	Blower	Jets 3	Undefined	Jets 3	Blower	Jets 3	Undefined
B4	Light 1	Light 1	Light 1	Light 1	Light 1	Light 1	Light 1	Light 1

# TP800 Panel Configuration

## Spa Screen

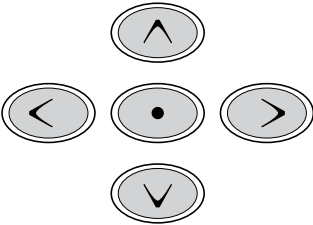
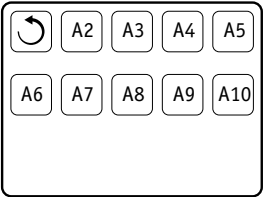
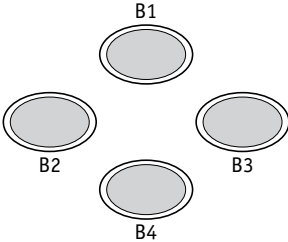

## Shortcuts Screen

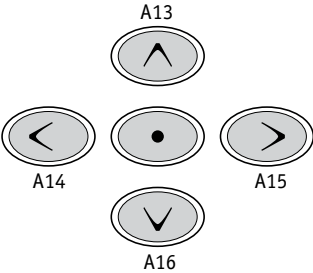
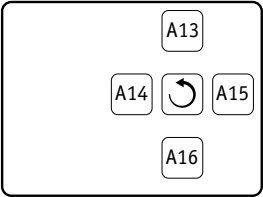
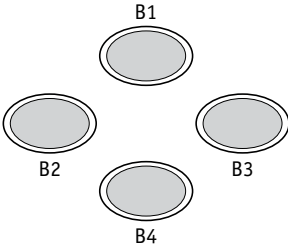

**Note:** Buttons 11 and 12 are not used in this configuration.  
Button 1 is fixed.

Panel Part Number \_\_\_\_\_

Overlay Part Number \_\_\_\_\_

*A Circ Icon will appear when a Circ Pump is configured.*

# TP900 Panel Configuration

**Button Layout Table**

Button #	Pump 3, Blower & Circ Setups 11, 12, 16	NO Pump 3, Blower & Circ Setup 9, 17	Pump 3, NO Blower & Circ Setups 7, 8, 13, 14	NO Pump 3, NO Blower & Circ Setup 10	Pump 3, Blower & NO Circ Setups 5, 15	NO Pump 3, Blower & NO Circ Setup 3, 18	Pump 3, NO Bl & NO Circ Setups 1, 2, 6	NO Pump 3, NO Bl & NO Circ Setup 4
1	N/A	N/A	N/A	N/A	N/A	N/A	N/A	N/A
2	Jets 1	Jets 1	Jets 1	Jets 1	Jets 1	Jets 1	Jets 1	Jets 1
3	Jets 2	Jets 2	Jets 2	Jets 2	Jets 2	Jets 2	Jets 2	Jets 2
4	Jets 3	Blower	Jets 3	Light 1	Jets 3	Blower	Jets 3	Light 1
5	Blower	Light 1	Light 1	Invert	Blower	Light 1	Light 1	Invert
6	Light 1	Invert	Invert	(Circ Icon)	Light 1	Invert	Invert	Undefined
7	Invert	(Circ Icon)	(Circ Icon)	Undefined	Invert	Undefined	Undefined	Undefined
8	(Circ Icon)	Undefined	Undefined	Undefined	Undefined	Undefined	Undefined	Undefined
9	Undefined	Undefined	Undefined	Undefined	Undefined	Undefined	Undefined	Undefined
10	Undefined	Undefined	Undefined	Undefined	Undefined	Undefined	Undefined	Undefined
11	N/A	N/A	N/A	N/A	N/A	N/A	N/A	N/A
12	N/A	N/A	N/A	N/A	N/A	N/A	N/A	N/A
13	Jets 1	Jets 1	Jets 1	Jets 1	Jets 1	Jets 1	Jets 1	Jets 1
14	Jets 2	Jets 2	Jets 2	Jets 2	Jets 2	Jets 2	Jets 2	Jets 2
15	Jets 3	Blower	Jets 3	Light	Jets 3	Blower	Jets 3	Light
16	Light	Light	Light	Invert	Light	Light	Light	Invert

*A Circ Icon will appear when a Circ Pump is configured.*

# TP900 Panel Configuration

Button #
1
2
3
4
5
6
7
8
9
10
11
12
13
14
15
16

## Spa Screen

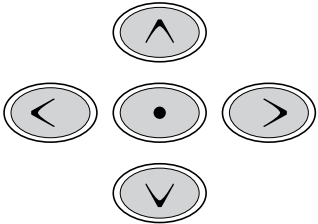
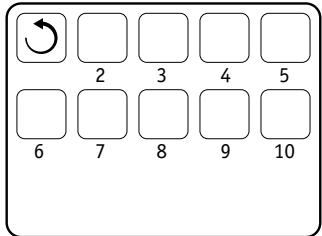

## Shortcuts Screen

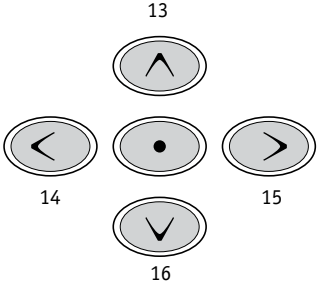
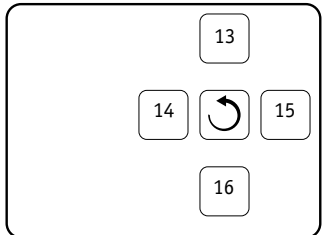

Manufactured under one or more of these patents. U.S. Patents: 5332944, 5361215, 5550753, 5559720, 5,883,459, 6253227, 6282370, 6590188, 6976052, 6965815, 7030343, 7,417,834 b2, Canadian Patent: 2342614, Australian patent: 2373248 other patents both foreign and domestic applied for and pending. © Copyright 2009 Balboa Water Group.



# BP2000 Configuration Options

---

## Auxilliary Panel Features on Bank 1\*

Feature	Default
Aux Button A1	Jets 1
Aux Button A2	Jets 2
Aux Button A3	Blower
Aux Button A4	Light

## Auxilliary Panel Features on Bank 2\*

Feature	Default
Aux Button A5	Jets 1
Aux Button A6	Jets 2
Aux Button A7	Jets 3
Aux Button A8	Light

Buttons that are assigned to equipment that is not defined in a Setup will not do anything in that Setup.

\*Bank 1 consists of J5 on the Main Circuit Board.  
Bank 2 consists of J8 on the Main Circuit Board.  
**Aux Connection Splitter PN25257 may be required.**

# BP2000 Configuration Options

## Auxilliary Panel Features

### AX10 Panels on Bank 1\*

A1, AX10A1	No O/L	52803	
A2, AX10A2	No O/L	52804	
A3, AX10A3	No O/L	52805	▶
A4, AX10A4	No O/L	52806	

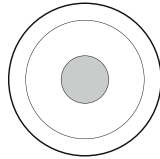

Call Customer Service for additional information about Auxiliary Panels.

Auxiliary Panel Part Number \_\_\_\_\_

Overlay Part Number \_\_\_\_\_

### AX10 Panels on Bank 2\*

A5, AX10A1	No O/L	52803
A6, AX10A2	No O/L	52804
A7, AX10A3	No O/L	52805
A8, AX10A4	No O/L	52806

\*Bank 1 consists of J5 on the Main Circuit Board.

Bank 2 consists of J8 on the Main Circuit Board.

**Aux Connection Splitter PN25257 may be required.**

### AX20

AX20 A1A2	No O/L	52800
AX20 A1A3	No O/L	52801
AX20 A1A4	No O/L	52802

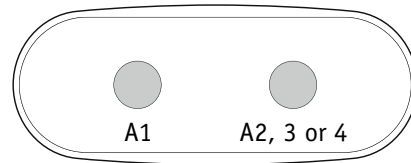

**AX20 Auxiliary Panel plugged into Bank 1 will operate A1 + A2, A3 or A4.**

**AX20 Auxiliary Panel plugged into Bank 2 will operate A5 + A6, A7 or A8.**

### AX40

AX40	No O/L	52799
------	--------	-------

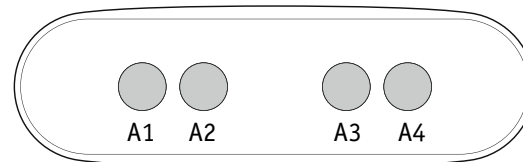

**AX40 Auxiliary Panel plugged into Bank 1 will operate A1 + A2, A3 and A4.**

**AX40 Auxiliary Panel plugged into Bank 2 will operate A5 + A6, A7 and A8.**



# BP2000 Configuration Options

## Remote Panel Features

Feature	Default
Remote Button A1	Jets 1
Remote Button A2	Jets 2
Remote Button A3	Jets 3
Remote Button A4	Blower
Remote Button A5	Light
Remote Button A6	Undefined
Remote Button A7	Undefined
Remote Button A8	Undefined

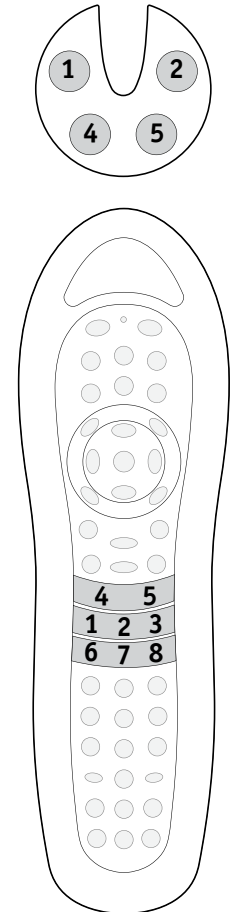

Buttons that are assigned to equipment that is not defined in a Setup will not do anything in that Setup.

Remote Panel Part Number \_\_\_\_\_  
 Overlay Part Number \_\_\_\_\_